

The Engineer's Tool Kit

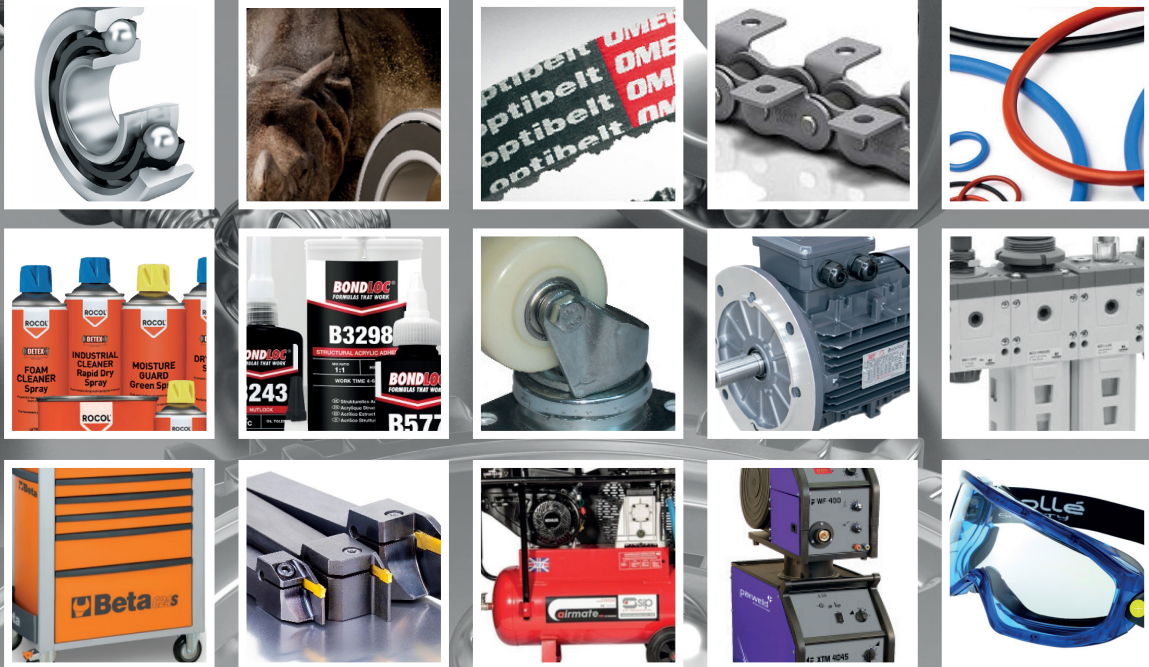

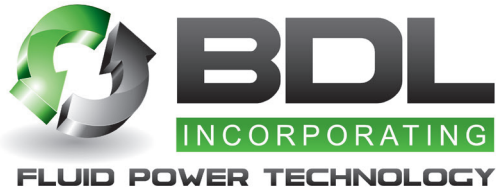

Established in 1996, Bearings and Drives has grown to be a leader in the supply and distribution of MRO products from the world's leading manufacturers including: Bearings, Power Transmission, Industrial Gearboxes, Motors, Tools & Consumables. Drawing on our experience of customer requirements products and services have been developed for all types of industry including Food, Paper, Recycling, Distribution, Quarrying and Plastics.

Due to the unpredictable nature of MRO spares demand, we offer single source supply which includes MANAGED INVENTORY SERVICES, which would, by streamlining your ordering process, REDUCE DOWNTIME and IMPROVE PRODUCTION EFFICIENCY therefore creating considerable COST SAVINGS.

Our REPAIR SERVICES cover Motors, Gearboxes & Pumps. Available 24/7 our team of highly skillful engineers is on hand to deliver advise and engineering solutions. We also offer a free collection and delivery service.

FLUID POWER

In 2009, and with many industries relying on Fluid Power in their manufacturing processes, our sister company FLUID POWER TECHNOLOGY was established and it has grown to not only carry large stocks of, FRL's, Solenoid Valves, Mechanical Valves, Metal & Plastic Fittings but also, due to the indepth knowledge and expertise of our staff, we are able to offer Product Interchange, System Advice and Bespoke Solutions to specific requirements, these being our Unique Selling Points, set us apart from the competition.

However large or small the requirement, however simple or complex the problem, both BEARINGS & DRIVES and FLUID POWER TECHNOLOGY prides themselves on meeting your requirement with on time, on budget solution and supply.



Emergency Call Out
Service 24 hours a
day 7 days a week
365 days a year



Electric Motors
Gearboxes
Drives

The UK's Largest Stockist of Electric Motors

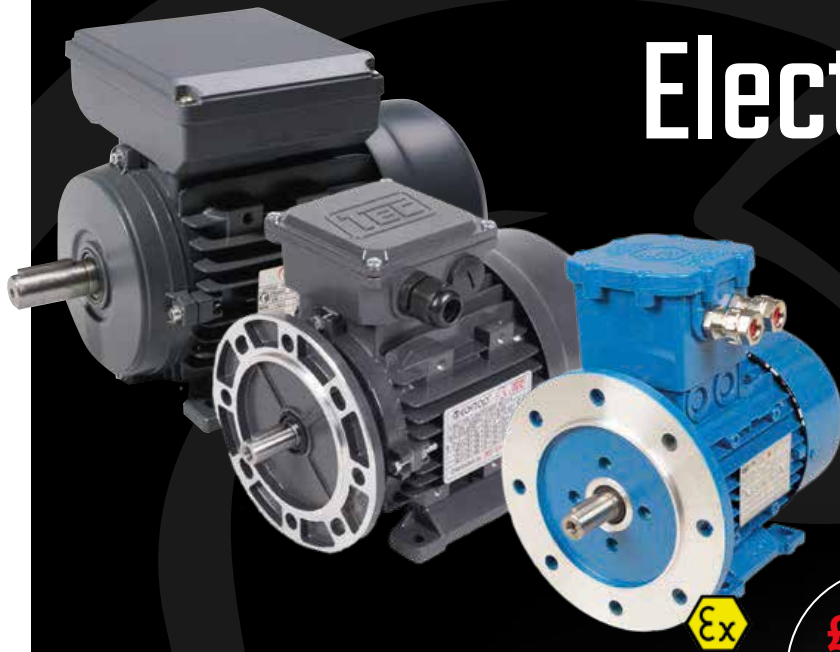

- > 1ph, 3ph & ATEX
- > 0.09 kW – 8 MW
- > 2, 4, 6 & 8 pole
- > Customisation & solutions
- > Application support
- > Online support portal
- > 24/7, 365 call out

£12m
UK stock
ready for dispatch
(£50m+ globally)

Gearboxes

Helical, hypoid & worm boxes



Drives

IP20, IP66, 1ph & 3ph



Our Spartan philosophy:

Dedication | Integrity | Reliability



www.iadaltd.co.uk

24/7, 365 - SERVICE THAT NEVER STOPS



The power of a global network

Electric Motors



TECA / TA Aluminium Motors 56-200 Frame
Multi mount and highly versatile. IE1, IE2 & IE3 0.09 kW – 37 kW.



TPC and TCC 1ph Aluminium Motors 56-112 Frame (including 3.7 kW!)
TPC: Fan, pump and square law torque applications.
TCC: High starting torque applications.



Large Frame Motors
Available from stock up to 630 kW 2 and 4 pole, in both standard and compact frames. IE3 efficiency with WIMES specification. MV and HV motors available on short lead times up to 8MW.



Elprom Zone 1 Exd Motors 63-180 Frame stocked
ATEX II 2G Exd IIC T4 Gb IP66 motors 2, 4 and 6 pole stocked. Thermistors as standard and suitable for use with any VSD.



ECOL Cast Iron 80-355 Frame
Multi mount and highly versatile. IE1, IE2 & IE3 0.75 kW – 315 kW.



TECA BM Brake Motors 71-200 Frame
TECA aluminium range with integrated brake at the none drive end fitted with hand release as standard. Multi mount and highly versatile.



TEC Zone 2 EXNA and Zone 22 EXT D 56-315 Frame
Thermistors as standard throughout the range. Multi mount to 280 frame.



TEC DC motors
Many styles, speeds and powers available for a variety of hydraulic applications.



B48 and B56 Motors
Imperial framed B48 and B56 motors available.



Motor Customisation & Solutions
Epoxy painting, anti condensation heaters, special bearings, IP upgrades, slide bases and rails, shaft extensions, retro fit brake motors, vector motors, forcevent motors, flying lead motors and much more.

Products Include:

- 2/4/6/8/10/12 pole
- 56-400 frame
- Multi mount 56-200 aluminium
- Multi mount 80-280 cast iron
- Fixed feet 315-400 cast iron
- IE1, IE2, IE3 & IE4 efficiency rated motors
- ECA approved IE3 motors
- Increased output IE1 and IE2
- 1ph motors 56-112 frame
- 1ph motors 230 V / 110 V
- 60 Hz 1ph motors also available
- ATEX Exd/EEExde Zone 1 71-355 frame
- ATEX Zone 2/22 56-355 frame
- ATEX Zone 21 & ATEX 1ph
- Brake motors, retro brake fitting
- Two speed dual & tap wound
- Special voltage, special shaft
- Vector encoder motors
- Forced ventilated motors
- In-line helical gearboxes
- Right angle hypoid gearboxes
- Right angle worm gearboxes
- Mechanical speed variators
- Slow speed combination units
- Inverters – IP20, IP66 & IP66 switched
- kVA & MW (Mega Watt) motors

MOTOR
PUMP &
GEARBOX

Gearboxes



TCNDK Worm Boxes Size 30-150
Ratios from 5/1 to 100/1. Helical worm and combination worms available.



Lightweight, High Efficiency Hypoid Gear Units
WAH50 to WAH90. Also interchangeable with worm gears from many popular manufacturers.



Official UK Varvel Distributor
TEC are an in-house build centre for Varvel and can create custom ratios and outputs throughout the RO/RV/RD from stock components, in addition to having access to all of Varvel's extensive product range on short lead times.

Drives



TEC Drive General Purpose Drives
Available in IP66, IP66 Switched, and IP20 panel mount models from 0.37 kW up to 22 kW. Produced with simplicity and reliability in mind, it is the ideal drive for use in many applications, particularly modular conveyor lines, fans and pumps. Other models available on short lead times up to 250 kW.



MS Series

Three-Phase Asynchronous Motors Aluminum Housing

MS series aluminum housing three-phase asynchronous motors with the latest design manufactured using high quality materials and conforming to provide exceptional IEC standard.

MS motors offer a high performance level along with safe and reliable low maintenance operation, whilst giving low noise levels and low vibration levels - all within a lightweight and simple construction.



MS/MSD Series Dimensional Drawings

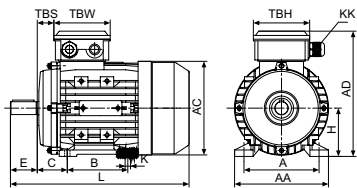

56-160 IM B3

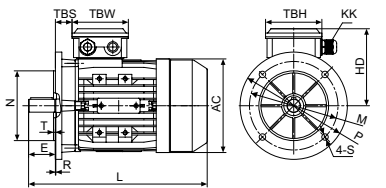

56-160 IM B5

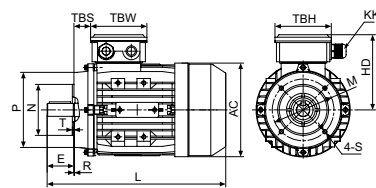

56-160 IM B14

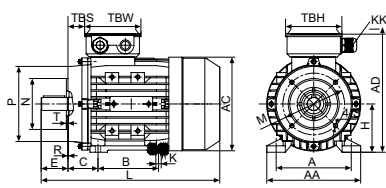

56-160 IM B34

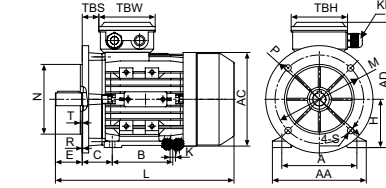

56-160 IM B35

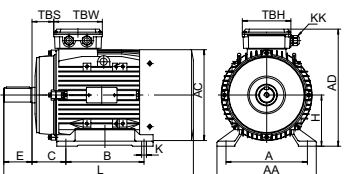
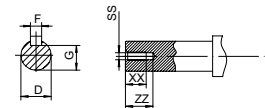

180-200 IM B3

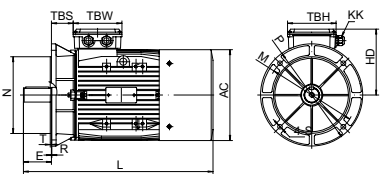

180-200 IM B5

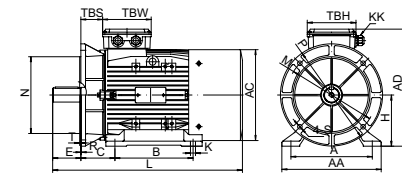

180-200 IM B35



MSBCCL Series

Asynchronous Three-Phase Brake Motors With Squirrel Cage Rotor - Direct Current Brake

▪ **MSBCCL series-enclosed construction externally ventilated-sizes 63~200**

The brake-motors of the MSBCCL series result from coupling an asynchronous three-phase motor and an electromagnetic D.C. brake unit. Due to their reliability and operating safety, as well as their quick braking time (connection & disconnection time = 5~80 milliseconds) they are suitable for a great variety of applications, such as:

- Braking of loads or torques on the driving shaft.
- Braking of rotating masses to reduce any lost-time.
- Braking operations to increase the set-up precision.
- Braking of machine parts, according to safely rules.



MOTOR
PUMP &
GEARBOX

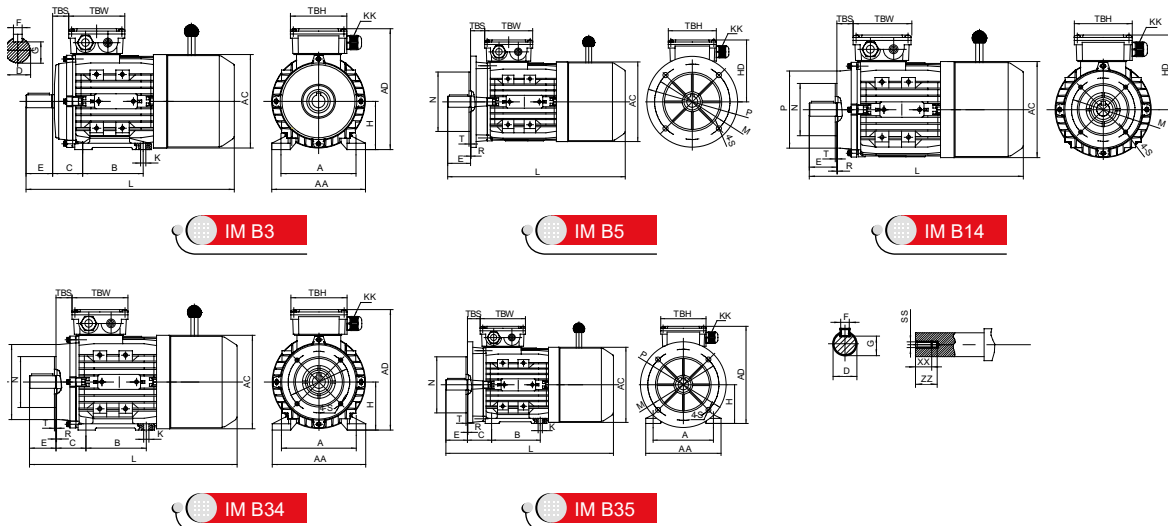

Overall & Installation Dimensions

FRAME	Foot Mounting				Shaft								General							
	H	A	B	C	D	E	F	G	K	SS	XX	ZZ	AA	AD	HD	AC	L	TBS	TBW	TBH
56	56	90	71	36	Φ9	20	3	7.2	5.8*8.8	M4	10	14	110	152	96	Φ110	233	14	88	88
63	63	100	80	40	Φ11	23	4	8.5	7*10	M4	10	14	120	169	106	Φ121	265	14	94	94
71 ^{3*}	71	112	90	45	Φ14	30	5	11	7*10	M5	12	17	132	184	113	Φ139	287/301	20	94	94
80	80	125	100	50	Φ19	40	6	15.5	10*13	M6	16	21	160	211	131	Φ156	340	27	105	105
90S	90	140	100	56	Φ24	50	8	20	10*13	M8	19	25	175	228	138	Φ175	356	30	105	105
90L1/L2	90	140	125	56	Φ24	50	8	20	10*13	M8	19	25	175	228	138	Φ175	381/411	30	105	105
100 ^{3*}	100	160	140	63	Φ28	60	8	24	12*15	M10	22	30	198	248	148	Φ196	434/452	26	105	105
112	112	190	140	70	Φ28	60	8	24	12*15	M10	22	30	220	278	166	Φ221	465	32	112	112
132S	132	216	140	89	Φ38	80	10	33	12*15	M12	28	37	252	316	184	Φ256	518	38	112	112
132ML	132	216	178	89	Φ38	80	10	33	12*15	M12	28	37	252	316	184	Φ256	556/582	38	112	112
160ML	160	254	210/254	108	Φ42	110	12	37	15*19	M16	36	45	290	382	222	Φ313	701	64	143	143

FRAME	KK	B5						B14						B5R						B14B					
		N	M	P	S	T	R	N	M	P	S	T	R	N	M	P	T	S	R	N	M	P	T	S	R
56	1-M16*1.5	Φ80	Φ100	Φ120	Φ7	3	0	Φ50	Φ65	Φ80	M5	2.5	0												
63	1-M16*1.5	Φ95	Φ115	Φ140	Φ10	3	0	Φ60	Φ75	Φ90	M5	2.5	0												
71	1-M20*1.5	Φ110	Φ130	Φ160	Φ10	3.5	0	Φ70	Φ85	Φ105	M6	2.5	0	Φ95	Φ115	Φ140	3	Φ10	0	Φ95	Φ115	Φ140	3	M8	0
80	1-M20*1.5	Φ130	Φ165	Φ200	Φ12	3.5	0	Φ80	Φ100	Φ120	M6	3	0	Φ110	Φ130	Φ160	3.5	Φ10	0	Φ110	Φ130	Φ160	3.5	M8	0
90	1-M20*1.5	Φ130	Φ165	Φ200	Φ12	3.5	0	Φ95	Φ115	Φ140	M8	3	0	Φ110	Φ130	Φ160	3.5	Φ10	0	Φ110	Φ130	Φ160	3.5	M8	0
100	2-M20*1.5	Φ180	Φ215	Φ250	Φ15	4	0	Φ110	Φ130	Φ160	M8	3.5	0	Φ130	Φ165	Φ200	3.5	Φ12	0	Φ130	Φ165	Φ200	3.5	M10	0
112	2-M25*1.5	Φ180	Φ215	Φ250	Φ15	4	0	Φ110	Φ130	Φ160	M8	3.5	0	Φ130	Φ165	Φ200	3.5	Φ12	0	Φ130	Φ165	Φ200	3.5	M10	0
132	2-M25*1.5	Φ230	Φ265	Φ300	Φ15	4	0	Φ130	Φ165	Φ200	M10	3.5	0	Φ180	Φ215	Φ250	4	Φ15	0	Φ180	Φ215	Φ250	4	M12	0
160	2-M32*1.5	Φ250	Φ300	Φ350	Φ19	5	0	Φ180	Φ215	Φ250	M12	4	0												

REACH brake data (fitted as standard)

Frame size	Brake type	Brake torque (Speed 100r/min) (Nm)	Brake rated power(20°C) (W)	Delay time when power on (ms)	Brake time (ms)	Pick in time when power off (ms)
56-71	06	4	20	15	30	40
80	08	8	25	15	32	50
90	10	16	30	25	45	69
100	12	32	40	26	56	108
112	14	60	50	27	57	190
132	16	80	55	30	60	200
160	18	150	85	35	78	260

INTORQ brake data

Frame size	Brake type	Brake torque (Speed 100r/min) (Nm)	Brake rated power (20°C) (W)	Delay time when power on (ms)	Brake time (ms)	Pick in time when power off (ms)
56-71	06	4	20	10	23	52
80	08	8	25	15	31	60
90	10	16	30	31	50	65
100	12	32	40	39	64	145
112	14	60	50	26	51	205
132	16	80	55	40	70	258



MOTOR
PUMP &
GEARBOX

MSB Series Motors Technical Data (at 50Hz)

Model	Power (kW)	Current (A)			Current (A)			Current (A)			Speed (r/ min)	Eff			Power factor	T _{st} /T _n (Times)	T _{max} /T _n (Times)	T _{max} /T _s (Times)	I _{st} /I _n (Times)	Noise dB(A)
		220V	380V	660V	230V	400V	690V	240V	415V	720V		100%	75%	50%						
MSB 631-6	0.09	0.75	0.44	0.25	0.72	0.41	0.24	0.69	0.40	0.23	890	50.7	47.6	39.8	0.62	2	2.2	1.9	2.9	50
MSB 632-6	0.12	0.97	0.56	0.32	0.93	0.54	0.31	0.89	0.52	0.30	895	53.7	50.9	43.2	0.60	2.3	2.2	2.1	2.8	50
MSB 711-6	0.18	1.11	0.64	0.37	1.06	0.61	0.35	1.02	0.59	0.34	905	63.0	61.6	55.4	0.67	2.15	2.4	2	3.5	52
MSB 712-6	0.25	1.56	0.90	0.52	1.49	0.86	0.50	1.43	0.83	0.48	885	62.6	62.0	55.8	0.67	2.05	2.3	2.05	3.2	52
MSB 713-6	0.37	2.32	1.34	0.77	2.22	1.28	0.74	2.13	1.23	0.71	890	65.4	64.4	58.2	0.64	2.3	2.5	2.3	3.4	54
MSB 801-6	0.37	2.06	1.19	0.69	1.97	1.13	0.66	1.89	1.09	0.63	920	68.1	67.7	62.2	0.69	1.95	2.25	1.8	3.7	56
MSB 802-6	0.55	2.74	1.59	0.91	2.62	1.51	0.87	2.51	1.45	0.84	920	72.5	73.0	69.3	0.73	2.25	2.45	2.05	4.3	56
MSB 803-6	0.75	3.65	2.11	1.22	3.49	2.01	1.16	3.34	1.93	1.11	910	72.9	74.2	71.3	0.74	2.2	2.4	2.1	4.1	58
MSB 90S-6	0.75	3.83	2.22	1.28	3.67	2.11	1.22	3.52	2.03	1.17	920	72.5	73.3	70.0	0.71	1.8	2.2	1.7	4.1	59
MSB 90L1-6	1.1	5.47	3.17	1.82	5.23	3.01	1.74	5.01	2.90	1.67	910	73.5	75.2	72.9	0.72	1.95	2.25	1.85	4.2	59
MSB 90L2-6	1.5	7.12	4.12	2.37	6.81	3.92	2.27	6.53	3.78	2.18	900	74.7	77	75.5	0.74	2.1	2.3	1.9	4.2	60
MSB 100L1-6	1.5	6.77	3.92	2.26	6.47	3.72	2.16	6.20	3.59	2.07	935	78.5	79.9	78.2	0.74	2.05	2.35	1.8	5	61
MSB 100L2-6	2.2	9.87	5.71	3.29	9.44	5.43	3.15	9.04	5.23	3.01	950	77	78.4	77.8	0.76	2.2	2.2	1.3	6	63
MSB 112M-6	2.2	9.3	5.38	3.10	8.89	5.11	2.96	8.52	4.93	2.84	925	79.2	81.8	81.7	0.78	1.9	2.25	1.75	4.7	64
MSB 112L-6	3	12.9	7.49	4.31	12.4	7.12	4.13	11.9	6.86	3.95	950	79	80.9	80.9	0.77	2.2	2.2	1.3	6	64
MSB 132S-6	3	12.5	7.22	4.16	11.9	6.86	3.98	11.4	6.61	3.81	955	82.5	84.5	84.3	0.77	1.7	2.15	1.45	5.3	64
MSB 132M1-6	4	16.2	9.39	5.40	15.5	8.92	5.17	14.9	8.59	4.95	965	85.2	85.8	84.4	0.76	2.3	2.9	1.6	6.6	68
MSB 132M2-6	5.5	21.5	12.4	7.16	20.6	11.8	6.9	19.7	11.4	6.6	960	85.9	87.2	86.8	0.78	2.5	2.7	1.7	6.7	68
MSB 132L-6	7.5	30.1	17.4	10.0	28.8	16.5	9.6	27.6	15.9	9.2	960	85	86.4	86.4	0.77	2	2	1.3	6.5	68
MSB 160M-6	7.5	30.3	17.6	10.1	29.0	16.7	9.7	27.8	16.1	9.3	970	86.8	87.6	86.7	0.75	2.1	2.7	1.65	6.1	68
MSB 160L-6	11	42.5	24.6	14.2	40.7	23.4	13.6	39.0	22.5	13.0	965	87.2	88.6	88.6	0.78	2.25	2.35	1.5	6.9	73
MSB 711-8	0.09	0.97	0.56	0.32	0.93	0.54	0.31	0.89	0.52	0.30	680	44.9	39.6	31.1	0.54	2.3	2.6	2.2	2.4	50
MSB 712-8	0.12	1.15	0.67	0.38	1.10	0.63	0.37	1.06	0.61	0.35	680	51.7	47.1	38.4	0.53	2.5	2.75	2.5	2.7	50
MSB 713-8	0.18	1.51	0.88	0.50	1.45	0.83	0.48	1.39	0.80	0.46	670	55.8	52.5	44.4	0.56	2.3	2.5	2.4	2.8	52
MSB 801-8	0.18	1.24	0.72	0.41	1.18	0.68	0.39	1.13	0.66	0.38	705	64.4	61.3	53.9	0.59	2.2	2.65	2	3.6	52
MSB 802-8	0.25	1.64	0.95	0.55	1.57	0.90	0.52	1.51	0.87	0.50	700	66.3	64.3	57.8	0.60	2.1	2.5	2.05	3.5	52
MSB 90S-8	0.37	2.37	1.37	0.79	2.26	1.30	0.75	2.17	1.25	0.72	690	66.3	65.4	59.6	0.62	1.55	2	1.5	3.2	56
MSB 90L-8	0.55	3.26	1.89	1.09	3.12	1.79	1.04	2.99	1.73	1.00	680	69.0	69.9	65.8	0.64	1.6	1.95	1.6	3.3	56
MSB 100L1-8	0.75	3.88	2.24	1.29	3.71	2.13	1.24	3.55	2.06	1.18	700	75.2	74.8	70.8	0.68	2.1	2.55	1.95	4.4	59
MSB 100L2-8	1.1	5.16	2.99	1.72	4.94	2.84	1.65	4.73	2.74	1.58	685	74.6	76.7	75.1	0.75	1.8	2.15	1.65	4.1	59
MSB 112M-8	1.5	7.24	4.19	2.41	6.93	3.98	2.31	6.64	3.84	2.21	700	78.3	78.9	76.4	0.69	2.2	2.5	2.1	4.5	61
MSB 132S-8	2.2	10.0	5.81	3.35	9.6	5.52	3.20	9.20	5.32	3.07	705	78.8	80.7	79.6	0.73	1.8	2.25	1.65	4.5	64
MSB 132M-8	3	13.0	7.51	4.33	12.4	7.14	4.14	11.9	6.88	3.96	705	80.9	82.6	81.9	0.75	2.1	2.5	1.8	5.1	64
MSB 160M1-8	4	18.0	10.4	5.99	17.2	9.88	5.73	16.5	9.53	5.49	710	81.7	83.0	82.0	0.72	1.8	2.25	1.5	4.7	68
MSB 160M2-8	5.5	23.4	13.5	7.79	22.4	12.9	7.45	21.4	12.4	7.14	715	84.6	85.7	84.9	0.73	2.15	2.55	1.6	5.2	68
MSB 160L-8	7.5	30.3	17.5	10.1	29.0	16.67	9.66	27.8	16.1	9.26	715	85.8	87.1	86.7	0.76	2.15	2.45	1.4	5.4	68

MOTOR
PUMP &
GEARBOX



ML Series

Single-Phase Capacitor Start and Capacitor Run Asynchronous Motors Aluminum Housing

ML series aluminum housing single-phase dual-capacitor asynchronous motors, with latest design in entirety, are made of selected quality materials and conform to the IEC standard. **ML** motors have good performance, safety and reliable operation, the multiple of starting torque is up to 2.5. These motors are typically used on applications where a high starting torque and high overload are required - such as air compressors, pumps, and many other small machines. Capable of 15 times/hour Start/Stops.

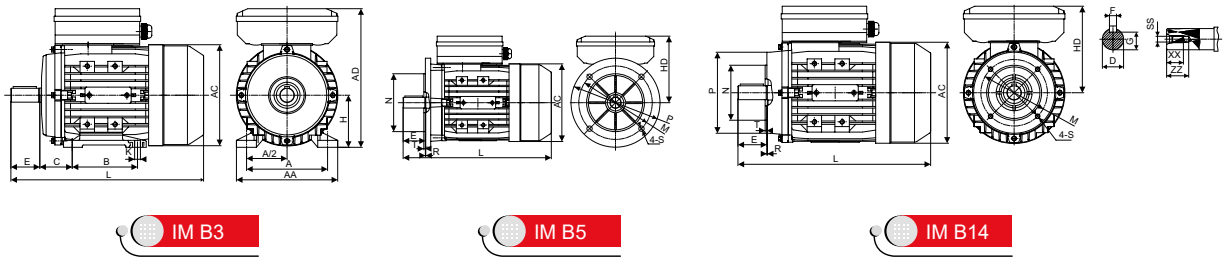

Overall & Installation Dimensions

FRAME	Mounting Dimensions									Overall Dimensions					Shaft End Screw Dimensions		
	H	A	B	C	D	E	F	G	K	AA	AD	HD	AC	L	SS	XX	ZZ
ML 63	63	100	80	40	Φ11	23	4	8.5	7×10	120	179	116	Φ121	220	M4	10	14
ML 71	71	112	90	45	Φ14	30	5	11	7×10	132	194	123	Φ139	255	M5	12	17
ML 80	80	125	100	50	Φ19	40	6	15.5	10×13	160	223	143	Φ156	290	M6	16	21
ML 90S	90	140	100	56	Φ24	50	8	20	10×13	175	240	150	Φ175	337	M8	19	25
ML 90L	90	140	125	56	Φ24	50	8	20	10×13	175	240	150	Φ175	367	M8	19	25
ML 100L	100	160	140	63	Φ28	60	8	24	12×15	198	271	171	Φ196	403(421)	M10	22	30
ML 112M	112	190	140	70	Φ28	60	8	24	12×15	220	297	185	Φ221	431	M10	22	30

FRAME	KK	B5						B14						B5R						B14B						
		N	M	P	S	T	R	N	M	P	S	T	R	N	M	P	T	S	R	N	M	P	T	S	R	
ML 63	1-M20*1.5	Φ95	Φ115	Φ140	Φ10	3	0	Φ60	Φ75	Φ90	M5	2.5	0													
ML 71	1-M20*1.5	Φ110	Φ130	Φ160	Φ10	3.5	0	Φ70	Φ85	Φ105	M6	2.5	0	Φ95	Φ115	Φ140	3	Φ10	0	Φ95	Φ115	Φ140	3	M8	0	
ML 80	1-M20*1.5	Φ130	Φ165	Φ200	Φ12	3.5	0	Φ80	Φ100	Φ120	M6	3	0	Φ110	Φ130	Φ160	3.5	Φ10	0	Φ110	Φ130	Φ160	3.5	M8	0	
ML 90	1-M20*1.5	Φ130	Φ165	Φ200	Φ12	3.5	0	Φ95	Φ115	Φ140	M8	3	0	Φ110	Φ130	Φ160	3.5	Φ10	0	Φ110	Φ130	Φ160	3.5	M8	0	
ML 100	1-M20*1.5	Φ180	Φ215	Φ250	Φ15	4	0	Φ110	Φ130	Φ160	M8	3.5	0	Φ130	Φ165	Φ200	3.5	Φ12	0	Φ130	Φ165	Φ200	3.5	M10	0	
ML 112	1-M25*1.5	Φ180	Φ215	Φ250	Φ15	4	0	Φ110	Φ130	Φ160	M8	3.5	0	Φ130	Φ165	Φ200	3.5	Φ12	0	Φ130	Φ165	Φ200	3.5	M10	0	



Technical Data (at 230V/50Hz)

Model	Power (kW)	Current (A)	Speed (r/min)	Eff (%)	Power factor (cos φ)	T _{st} /T _n (Times)	T _{max} /T _n (Times)	Starting Current(A)	Run Capacitor (μf/V)	Start Capacitor (μf/V)	Noise dB(A)	W.T (kg)	Inertia (kg·m ²)
ML631-2	0.18	1.36	2820	62	0.93	1.9	1.8	7	8μf/450V	30μf/250V	70	3.9	0.000141
ML632-2	0.25	1.71	2800	67.5	0.94	2.3	1.8	8	10μf/450V	30μf/250V	70	4.4	0.000168
ML711-2	0.37	2.40	2780	70.5	0.95	2.5	1.6	12	12μf/450V	40μf/250V	75	6.2	0.000330
ML712-2	0.55	3.31	2790	74.5	0.97	2.5	1.8	20	16μf/450V	50μf/250V	75	7	0.000437
ML801-2	0.75	4.25	2840	77.5	0.99	2.5	1.8	30	20μf/450V	75μf/250V	75	9	0.000781
ML802-2	1.1	6.08	2850	79.5	0.99	2.3	1.8	40	30μf/450V	120μf/250V	78	10.3	0.000938
ML90S-2	1.5	8.23	2860	80	0.99	2.5	1.8	56	40μf/450V	200μf/300V	80	13.8	0.001512
ML90M-2	1.8	9.76	2860	81	0.99	2.5	1.8	65	40μf/450V	200μf/300V	80	15.1	0.001752
ML90L-2	2.2	11.9	2850	81	0.99	2.5	1.75	15	50μf/450V	250μf/300V	80	16.8	0.001995
ML100L-2	3	17.7	2830	75	0.98	2.5	1.63	110	60μf/450V	300μf/300V	83	25	0.004803
ML112M1-2	3.7	19.9	2900	82.5	0.98	2.5	1.8	155	60μf/450V	400μf/300V	84	31	0.007170
ML112M2-2	4	21.3	2900	83.5	0.98	2.5	1.8	165	60μf/450V	400μf/300V	84	33	0.007453
ML631-4	0.12	1.01	1380	54.5	0.95	2.5	1.65	6	8μf/450V	30μf/250V	65	4.1	0.000291
ML632-4	0.18	1.36	1340	60	0.96	2.3	1.43	6	10μf/450V	30μf/250V	65	4.5	0.000340
ML711-4	0.25	1.78	1415	63	0.97	2.5	1.7	10	12μf/450V	40μf/250V	65	5.9	0.000598
ML712-4	0.37	2.53	1410	65.5	0.97	2.3	1.6	15	16μf/450V	50μf/250V	68	6.9	0.000760
ML800-4	0.37	2.52	1420	66.5	0.96	2.5	1.8	15	16μf/450V	50μf/250V	68	8.5	0.001105
ML801-4	0.55	3.52	1420	71.5	0.95	2.5	1.8	20	20μf/450V	75μf/250V	70	9.6	0.001380
ML802-4	0.75	4.56	1420	73	0.98	2.5	1.75	27	25μf/450V	100μf/250V	70	10.9	0.001656
ML90S-4	1.1	6.62	1420	76	0.95	2.5	1.7	40	35μf/450V	150μf/250V	73	13.8	0.002510
ML90L-4	1.5	8.56	1420	78.5	0.97	2.5	1.75	55	40μf/450V	200μf/300V	75	16.7	0.003252
ML100L0-4	1.84	10.3	1440	79.5	0.98	2.3	1.62	60	50μf/450V	200μf/300V	77	21	0.006804
ML100L1-4	2.2	12.1	1440	80.5	0.98	2.5	1.65	80	50μf/450V	250μf/300V	78	22.8	0.008045
ML100L2-4	3	16.4	1445	83	0.96	2.4	1.75	110	60μf/450V	300μf/300V	78	28.7	0.010543
ML112M1-4	3.7	19.7	1430	83.5	0.98	2.4	1.75	130	60μf/450V	400μf/300V	79	31	0.013608
ML112M2-4	4	21.3	1435	83.5	0.98	2.5	1.75	140	60μf/450V	400μf/300V	79	32.8	0.014485
ML711-6	0.18	1.3	930	60	0.97	2.3	1.72	7	10μf/450V	40μf/250V	68	6.7	0.000965
ML801-6	0.37	2.5	935	67	0.97	2.2	1.55	13	16μf/450V	50μf/250V	68	10.1	0.001829
ML802-6	0.55	3.5	935	71	0.97	2.2	1.45	20	20μf/450V	75μf/250V	70	10.8	0.002366
ML90S-6	0.75	4.7	945	71	0.97	2.1	1.45	35	30μf/450V	150μf/250V	70	14.2	0.003534
ML90L-6	1.1	6.7	945	74	0.96	2.5	1.45	45	45μf/450V	200μf/300V	70	17.3	0.004792
ML100L-6	1.5	8.73	960	77	0.97	2.3	1.55	60	45μf/450V	200μf/300V	72	23.8	0.010784
ML112M-6	2.2	12.0	965	82	0.97	2.5	1.7	100	60μf/450V	400μf/300V	75	31.2	0.019523

MOTOR
PUMP &
GEARBOX



MY/MYT Series

Single-Phase Capacitor Run Asynchronous Motors

Aluminum Housing

MY/MYT series aluminum housing single-phase capacitor-run asynchronous motors, with latest design in entirety, are made of selected quality materials and conform to the IEC standard. **MY** motors offer a high performance level along with safe and reliable low maintenance operation, whilst giving low noise levels and low vibration levels - all within a lightweight and simple construction. These motors are suitable for applications with low starting torque requirements and long-term continuous operation - such as home electric appliances, pumps, fans, and recording meters, etc.

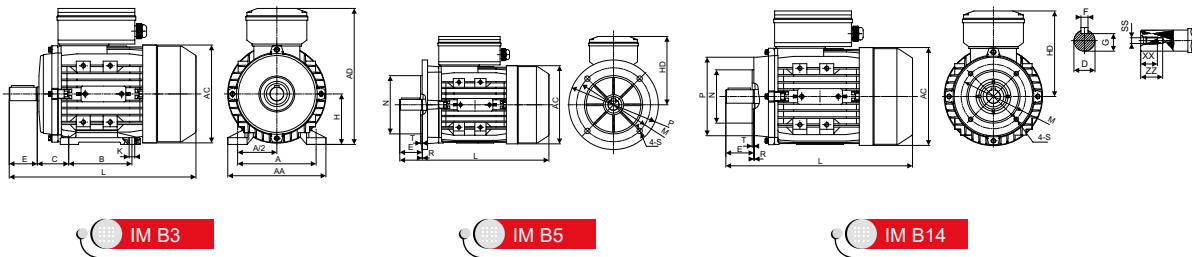

MOTOR
PUMP &
GEARBOX

Overall & Installation Dimensions

FRAME	Mounting Dimensions									Overall Dimensions					Shaft End Screw Dimensions		
	H	A	B	C	D	E	F	G	K	AA	AD	HD	AC	L	SS	XX	ZZ
MY 56	56	90	71	36	Φ9	20	3	7.2	5.8×8.8	110	144	88	Φ110	196	M4	9	12
MY 63	63	100	80	40	Φ11	23	4	8.5	7×10	120	181	118	Φ121	220	M4	10	14
MY 71	71	112	90	45	Φ14	30	5	11	7×10	132	196	125	Φ139	241/255	M5	12	17
MY 80	80	125	100	50	Φ19	40	6	15.5	10×13	160	226	146	Φ156	290	M6	16	21
MY 90S	90	140	100	56	Φ24	50	8	20	10×13	175	243	153	Φ175	312	M8	19	25
MY 90L	90	140	125	56	Φ24	50	8	20	10×13	175	243	153	Φ175	337/367	M8	19	25
MY 100L	100	160	140	63	Φ28	60	8	24	12×15	198	265	165	Φ196	368/386	M10	22	30

FRAME	KK	B5						B14						B5R						B14B					
		N	M	P	S	T	R	N	M	P	S	T	R	N	M	P	T	S	R	N	M	P	T	S	R
MY 56	1-M16*1.5	Φ80	Φ100	Φ120	Φ7	3	0	Φ50	Φ65	Φ80	M5	2.5	0												
MY 63	1-M20*1.5	Φ95	Φ115	Φ140	Φ10	3	0	Φ60	Φ75	Φ90	M5	2.5	0							Φ80	Φ100	Φ120	3	M6	0
MY 71	1-M20*1.5	Φ110	Φ130	Φ160	Φ10	3.5	0	Φ70	Φ85	Φ105	M6	2.5	0	Φ95	Φ115	Φ140	3	Φ10	0	Φ95	Φ115	Φ140	3	M8	0
MY 80	1-M20*1.5	Φ130	Φ165	Φ200	Φ12	3.5	0	Φ80	Φ100	Φ120	M6	3	0	Φ110	Φ130	Φ160	3.5	Φ10	0	Φ110	Φ130	Φ160	3.5	M8	0
MY 90	1-M20*1.5	Φ130	Φ165	Φ200	Φ12	3.5	0	Φ95	Φ115	Φ140	M8	3	0	Φ110	Φ130	Φ160	3.5	Φ10	0	Φ110	Φ130	Φ160	3.5	M8	0
MY 100	1-M20*1.5	Φ180	Φ215	Φ250	Φ15	4	0	Φ110	Φ130	Φ160	M8	3.5	0	Φ130	Φ165	Φ200	3.5	Φ12	0	Φ130	Φ165	Φ200	3.5	M10	0



Technical Data (at 230V/50Hz)

Model	Power (kW)	Current (A)	Speed (r/min)	Eff (%)	Power factor (cos Φ)	T _{st} /T _n (Times)	T _{max} /T _n (Times)	Starting Current(A)	Run Capacitor (μF/V)	Noise dB(A)	W.t. (Kg)	Inertia (kg*m ²)
MY561-2	0.09	0.81	2750	51	0.95	0.7	1.7	2	5μf/450V	67	3	0.000093
MY562-2	0.12	0.89	2800	61	0.96	0.7	1.8	3.1	6μf/450V	67	3.2	0.000120
MY631-2	0.18	1.31	2770	62	0.96	0.55	1.8	4.5	8μf/450V	70	3.8	0.000141
MY632-2	0.25	1.65	2780	68	0.97	0.55	1.8	6	10μf/450V	70	4.5	0.000168
MY633-2	0.37	2.51	2780	67.5	0.95	0.46	1.65	8	12μf/450V	75	5	0.000216
MY634-2	0.55	3.52	2740	70	0.97	0.46	1.55	12	16μf/450V	75	5.5	0.000249
MY711-2	0.37	2.54	2780	68	0.93	0.5	1.64	9.5	12μf/450V	75	5.5	0.000330
MY712-2	0.55	3.45	2800	73	0.95	0.5	1.8	14.5	16μf/450V	75	6.7	0.000356
MY713-2	0.75	4.45	2840	75.5	0.97	0.48	1.8	20	25μf/450V	75	7	0.000436
MY801-2	0.75	4.51	2810	73	0.99	0.45	1.75	19	25μf/450V	75	8.9	0.000789
MY802-2	1.1	6.30	2810	77.5	0.98	0.45	1.8	30	35μf/450V	78	11	0.001174
MY803-2	1.5	8.48	2820	78.5	0.98	0.34	1.68	40	40μf/450V	80	12.7	0.001430
MY90S-2	1.5	8.45	2820	78	0.99	0.33	1.72	35	45μf/450V	80	12.2	0.001512
MY90L-2	2.2	12.08	2850	80	0.99	0.29	1.8	61	60μf/450V	80	15.5	0.001983
MY100L-2	3	16.7	2860	79	0.99	0.35	1.8	73	80μf/450V	83	23.1	0.004803
MY561-4	0.06	0.55	1410	49	0.97	0.7	1.8	1.5	4μf/450V	63	2.9	0.000215
MY562-4	0.09	0.78	1390	51	0.99	0.7	1.65	8	6μf/450V	63	3.4	0.000240
MY631-4	0.12	0.97	1400	55	0.98	0.7	1.75	2.5	8μf/450V	65	3.4	0.000298
MY632-4	0.18	1.35	1380	59	0.98	0.6	1.65	3.5	10μf/450V	65	4.4	0.000373
MY633-4	0.25	1.77	1380	62.5	0.98	0.55	1.6	5	12μf/450V	65	5	0.000448
MY710-4	0.18	1.33	1420	60.5	0.97	0.48	1.65	4	10μf/450V	65	5.2	0.000538
MY711-4	0.25	1.70	1410	64.5	0.99	0.5	1.6	5	12μf/450V	65	5.8	0.000641
MY712-4	0.37	2.43	1410	67.5	0.98	0.44	1.65	7.5	16μf/450V	68	6.9	0.000846
MY713-4	0.55	3.45	1385	70	0.99	0.45	1.47	10.5	20μf/450V	70	8.3	0.001052
MY800-4	0.37	2.38	1420	69	0.98	0.45	1.8	9	16μf/450V	68	8	0.001285
MY801-4	0.55	3.34	1420	73	0.98	0.45	1.78	13	20μf/450V	70	9.5	0.001618
MY802-4	0.75	4.42	1420	74.5	0.99	0.44	1.71	16.5	30μf/450V	70	10.5	0.002061
MY90S-4	1.1	6.30	1420	77.5	0.98	0.35	1.75	24	40μf/450V	73	13.1	0.002500
MY90L-4	1.5	8.55	1420	79.5	0.96	0.33	1.8	36	45μf/450V	75	16.5	0.003240
MY100L1-4	2.2	13.0	1450	79	0.93	0.31	1.8	65	70μf/450V	78	23.4	0.008045
MY100L2-4	3	16.8	1450	81	0.96	0.31	1.8	91	90μf/450V	78	28.7	0.010853
MY631-6	0.09	0.9	900	44.5	0.97	0.38	1.53	2	8μf/450V	63	4.4	0.000550
MY632-6	0.12	1.1	875	47.5	0.98	0.25	1.23	2	11μf/450V	63	5.5	0.000649
MY711-6	0.18	1.5	920	55.5	0.97	0.5	1.5	3.5	11μf/450V	68	6.2	0.000585
MY712-6	0.25	2.0	930	56	0.98	0.45	1.5	5	16μf/450V	68	7.3	0.001151
MY801-6	0.37	2.5	960	66	0.96	0.35	1.6	8.5	20μf/450V	68	9	0.002232
MY802-6	0.55	3.5	955	70.5	0.97	0.35	1.6	12	25μf/450V	70	11.6	0.002903
MY90S-6	0.75	5.0	905	67	0.98	0.35	1.6	13	35μf/450V	70	13.5	0.003523
MY90L-6	1.1	6.6	940	74	0.98	0.35	1.5	25	50μf/450V	70	16.2	0.004957

MOTOR
PUMP &
GEARBOX



Technical Data (at 230V/50Hz)

Model	Power (kW)	Current (A)	Speed (r/min)	Eff (%)	Power Factor (cos φ)	T _{st} /T _n (Times)	T _{max} /T _n (Times)	Starting Current(A)	Run Capacitor (μf/V)	Noise dB(A)	W.L. (Kg)	Inertia (kg·m ²)
MYT631-2	0.18	1.29	2750	62	0.98	0.7	1.8	4	10μf/450V	70	3.8	0.000141
MYT632-2	0.25	1.71	2750	65	0.98	0.65	1.75	5.5	12μf/450V	70	4.5	0.000168
MYT633-2	0.37	2.39	2740	68	0.99	0.7	1.8	8	16μf/450V	75	5	0.000216
MYT711-2	0.37	2.59	2640	66	0.94	0.7	1.65	8	14μf/450V	75	6	0.000356
MYT712-2	0.55	3.52	2760	71.5	0.95	0.7	1.8	14	20μf/450V	75	7.4	0.000489
MYT801-2	0.75	4.87	2760	69	0.97	0.7	1.8	17.5	25μf/450V	75	9	0.001007
MYT802-2	1.1	6.53	2780	74	0.99	0.7	1.8	25	40μf/450V	78	11.6	0.001238
MYT90S-2	1.5	8.56	2755	77	0.99	0.65	1.8	31	50μf/450V	80	13	0.001665
MYT90L-2	2.2	12.39	2765	78	0.99	0.65	1.8	51	70μf/450V	80	17.8	0.002136
MYT90L2-2	3	16.68	2800	79	0.99	0.48	1.8	85	90μf/450V	83	22.3	0.002686
MYT100L0-2	2.2	12.68	2825	77	0.98	0.55	1.8	13	70μf/450V	80	21	0.004803
MYT100L-2	3	17.11	2765	77	0.99	0.55	1.75	64	90μf/450V	83	23.7	0.005383
MYT561-4	0.06	0.55	1410	49	0.97	0.7	1.8	1.5	4μf/450V	63	3.3	0.000215
MYT562-4	0.09	0.78	1390	51	0.99	0.7	1.65	8	6μf/450V	63	3.6	0.000240
MYT631-4	0.12	0.97	1400	55	0.98	0.7	1.75	2.5	8μf/450V	65	4.4	0.000298
MYT632-4	0.18	1.35	1380	59	0.98	0.6	1.65	3.5	10μf/450V	65	5.1	0.000373
MYT633-4	0.25	1.76	1380	62.5	0.99	0.63	1.57	5	14μf/450V	65	5.4	0.000448
MYT711-4	0.25	1.81	1310	60.5	0.99	0.7	1.55	4.5	14μf/450V	65	6	0.000692
MYT712-4	0.37	2.48	1325	65.5	0.99	0.7	1.52	6.5	20μf/450V	68	7.1	0.000898
MYT800-4	0.37	2.63	1350	63	0.97	0.7	1.7	7.5	16μf/450V	68	8.5	0.001396
MYT801-4	0.55	3.70	1330	66	0.98	0.7	1.57	10.5	25μf/450V	73	10	0.001728
MYT802-4	0.75	4.82	1355	69	0.98	0.67	1.65	16	35μf/450V	73	11.4	0.002393
MYT90S-4	1.1	6.94	1355	72.5	0.95	0.68	1.8	22	40μf/450V	75	14.3	0.002743
MYT90L-4	1.5	9.28	1360	74	0.95	0.68	1.8	32	50μf/450V	78	17.3	0.003483
MYT100L1-4	2.2	12.64	1390	78	0.97	0.48	1.75	49	70μf/450V	80	24.5	0.008665
MYT100L2-4	3	16.57	1380	79.5	0.99	0.45	1.6	61	90μf/450V	80	32	0.010853
MYT711-6	0.18	1.52	930	52	0.99	0.65	1.7	3.5	14μf/450V	68	6.2	0.000585
MYT712-6	0.25	2.12	925	54	0.95	0.58	1.7	5	16μf/450V	68	7.3	0.001151
MYT801-6	0.37	2.63	925	63	0.97	0.67	1.7	7.5	20μf/450V	68	9	0.002232
MYT802-6	0.55	3.71	915	66.5	0.97	0.63	1.7	11	30μf/450V	70	11.6	0.002903
MYT90S-6	0.75	4.93	890	67.5	0.98	0.65	1.5	12	40μf/450V	70	13.5	0.003523
MYT90L-6	1.1	7.15	905	69	0.97	0.55	1.7	21	50μf/450V	70	16.2	0.004957

* Note: MYT is high starting torque series single phase capacitor-run motors

TA Series

Three-Phase Asynchronous Motors Aluminum Housing

FEATURES

- Energy savings, high efficiency
- High starting torque, lower starting current
- Versatile and easy to modify design adapts to a variety of applications
- Removable feet
- Option of terminal box location (top, left or right)
- Option of IE2, IE3, MEPS High and Premium Efficiency for IEC standards + NEMA EPACT and Premium Efficiency
- Contained total length is the same as or shorter than the current market standard
- Full use of the magnetization properties of cold rolled silicone steel in which the stator laminations are magnetized evenly to reduce temperature rise of the winding

APPLICATIONS

- Pumps
- Waste water treatment plants
- Air compressors, fans
- Gear reducers and power transmission
- Pulp and paper mills
- Steel mill
- Conveyors, elevators
- "Material handling equipment"
- Agricultural application
- Mining equipment
- Hydraulic equipment



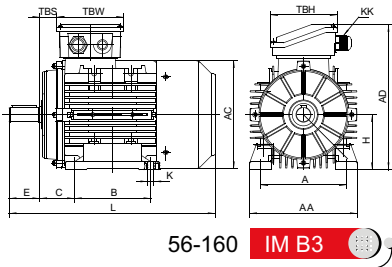

56-160 IM B3

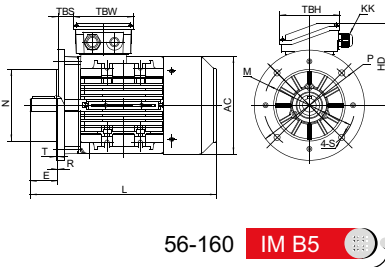

56-160 IM B5

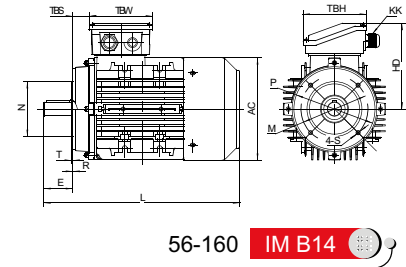

56-160 IM B14

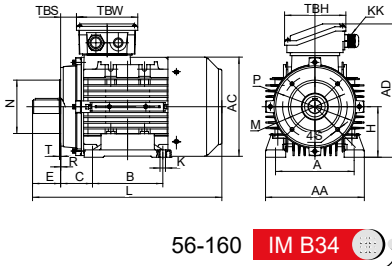

56-160 IM B34

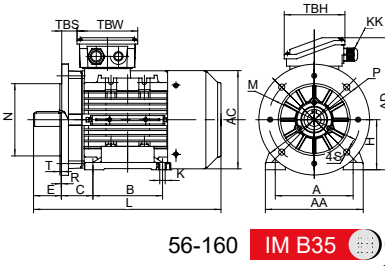

56-160 IM B35

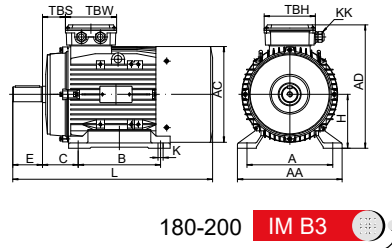
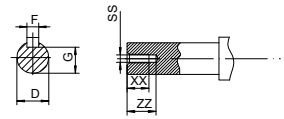

180-200 IM B3

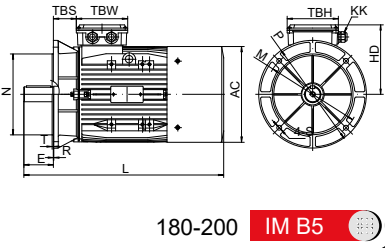

180-200 IM B5

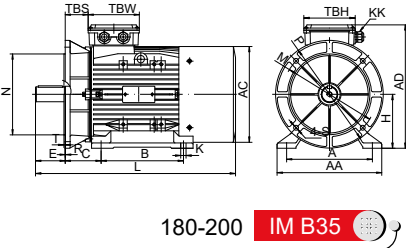

180-200 IM B35

Overall & Installation Dimensions

FRAME	Foot Mounting				Shaft								General							
	H	A	B	C	D	E	F	G	K	SS	XX	ZZ	AA	AD	HD	AC	L	TBS	TBW	TBH
TA 56	56	90	71	36	Φ9	20	3	7.2	6×9	M4	10	14	112	151	95	Φ110	195	16.5	83	83
TA 63	63	100	80	40	Φ11	23	4	8.5	7×10	M4	10	14	124	172	109	Φ122	217	10	98	98
TA 71	71	112	90	45	Φ14	30	5	11	7×10	M5	12	17	140	189	118	Φ138	245	16	98	98
TA 80	80	125	100	50	Φ19	40	6	15.5	10×15	M6	16	21	160	214	134	Φ157	227/304*	26.5	109	109
TA 90S	90	140	100	56	Φ24	50	8	20	10×15	M8	19	25	176	235	145	Φ177	315/340*	28.5	109	109
TA 90L	90	140	125	56	Φ24	50	8	20	10×15	M8	19	25	176	235	145	Φ177	340/365*	28.5	109	109
TA 100	100	160	140	63	Φ28	60	8	24	12×16	M10	22	30	200	260	160	Φ199	376/411*	32	118	118
TA 112	112	190	140	70	Φ28	60	8	24	12×16	M10	22	30	224	283	171	Φ220	398	33	118	118
TA 132S/M	132	216	140/178	89	Φ38	80	10	33	12×16	M12	28	37	260	323	191	Φ261	460/498	36.5	118	118
TA 160M/L	160	254	210/254	108	Φ42	110	12	37	15×21	M16	36	45	314	391	231	Φ314	616/660	64	148	148
TA 180	180	279	241/279	121	Φ48	110	14	42.5	15×25	M16	36	45	340	440	260	Φ355	730	73	190	190
TA200	200	318	305	133	Φ55	110	16	49	19×29	M20	42	53	390	460	260	Φ355	745	85	190	190

FRAME	KK	B5						B14						B5R						B14B						
		N	M	P	S	T	R	N	M	P	S	T	R	N	M	P	T	S	R	N	M	P	T	S	R	
TA 56	1-M16*1.5	Φ80	Φ100	Φ120	Φ7	3	0	Φ50	Φ65	Φ80	M5	2.5	0													
TA 63	1-M16*1.5	Φ95	Φ115	Φ140	Φ10	3	0	Φ60	Φ75	Φ90	M5	2.5	0													
TA 71	1-M20*1.5	Φ110	Φ130	Φ160	Φ10	3.5	0	Φ70	Φ85	Φ105	M6	2.5	0	Φ95	Φ115	Φ140	3	Φ10	0	Φ95	Φ115	Φ140	3	M8	0	
TA 80	1-M20*1.5	Φ130	Φ165	Φ200	Φ12	3.5	0	Φ80	Φ100	Φ120	M6	3	0	Φ110	Φ130	Φ160	3.5	Φ10	0	Φ110	Φ130	Φ160	3.5	M8	0	
TA 90S/L	1-M20*1.5	Φ130	Φ165	Φ200	Φ12	3.5	0	Φ95	Φ115	Φ140	M8	3	0	Φ110	Φ130	Φ160	3.5	Φ10	0	Φ110	Φ130	Φ160	3.5	M8	0	
TA 100	2-M20*1.5	Φ180	Φ215	Φ250	Φ15	4	0	Φ110	Φ130	Φ160	M8	3.5	0	Φ130	Φ165	Φ200	3.5	Φ12	0	Φ130	Φ165	Φ200	3.5	M10	0	
TA 112	2-M25*1.5	Φ180	Φ215	Φ250	Φ15	4	0	Φ110	Φ130	Φ160	M8	3.5	0	Φ130	Φ165	Φ200	3.5	Φ12	0	Φ130	Φ165	Φ200	3.5	M10	0	
TA 132S/M	2-M25*1.5	Φ230	Φ265	Φ300	Φ15	4	0	Φ130	Φ165	Φ200	M10	3.5	0	Φ180	Φ215	Φ250	4	Φ15	0	Φ180	Φ215	Φ250	4	M12	0	
TA 160M/L	2-M32*1.5	Φ250	Φ300	Φ350	Φ19	5	0	Φ180	Φ215	Φ250	M12	4	0													
TA 180	2-M32*1.5	Φ250	Φ300	Φ350	Φ19	5	0																			
TA200	2-M40*1.5	Φ300	Φ350	Φ400	Φ19	5	0																			



MOTOR
PUMP &
GEARBOX

T3A Series IE3 Efficiency Motors Technical Data (at 50Hz)

Model	Power	Current(A)			Current(A)			Current(A)			Speed (r/min)	Eff.			Power Factor	T _{start} /T _n (Times)	T _{max} /T _n (Times)	T _{max1} /T _n (Times)	I _f /I _n (Times)	Noise dB(A)	W.T (kg)	Inertia (kg·m ²)
		220V	380V	660V	230V	400V	690V	240V	415V	720V		100%	75%	50%								
T3A 631-2	0.18	0.96	0.55	0.32	0.91	0.53	0.30	0.88	0.51	0.29	2850	65.9	63.5	56.2	0.75	2	2.5	1.6	4.7	61	3.6	0.00023100
T3A 632-2	0.25	1.21	0.70	0.40	1.15	0.66	0.38	1.11	0.64	0.37	2840	69.7	68.4	62.5	0.78	2.5	2.7	2	5.2	61	3.9	0.00025500
T3A 711-2	0.37	1.74	1.00	0.58	1.65	0.95	0.55	1.59	0.92	0.53	2860	73.8	72.4	66.5	0.76	2.5	2.8	1.8	5.6	64	5.2	0.00036900
T3A 712-2	0.55	2.33	1.34	0.78	2.21	1.28	0.74	2.13	1.23	0.71	2860	77.8	76.5	66.2	0.8	3.1	3.1	2	6.5	64	6.2	0.00049500
T3A 713-2	0.75	2.98	1.72	0.99	2.83	1.64	0.94	2.73	1.58	0.91	2870	80.7	80.8	78.2	0.82	3	3.2	2.2	7.1	65	7.1	0.00060600
T3A 801-2	0.75	3.02	1.74	1.01	2.87	1.66	0.96	2.76	1.60	0.92	2890	80.7	80.3	77.2	0.81	3.1	3.2	2.3	7.4	67	8.9	0.00097215
T3A 802-2	1.1	4.27	2.46	1.42	4.06	2.34	1.35	3.91	2.26	1.30	2900	82.7	82.5	79.9	0.82	3.2	3.2	2.2	7.8	67	10.6	0.00127539
T3A 803-2	1.5	5.79	3.34	1.93	5.50	3.17	1.83	5.30	3.06	1.77	2910	84.2	83.9	81.5	0.81	4	4	2.2	9.6	70	12.5	0.00165443
T3A 90S-2	1.5	5.72	3.30	1.91	5.43	3.14	1.81	5.24	3.02	1.75	2900	84.2	83.8	81.4	0.82	3.5	3.7	2.1	8.3	72	14	0.00218574
T3A 90L1-2	2.2	8.02	4.63	2.67	7.62	4.40	2.54	7.35	4.24	2.45	2910	85.9	86.1	84.7	0.84	3.3	3.7	1.5	9	72	16.3	0.00263595
T3A 90L2-2	3	11.3	6.54	3.78	10.8	6.21	3.59	10.4	5.99	3.46	2910	87.1	87.1	84.2	0.8	4	4.1	2.6	9.6	74	18.5	0.00340596
T3A 100L1-2	3	10.2	5.88	3.39	9.68	5.59	3.23	9.33	5.38	3.11	2910	87.1	87.5	86.3	0.89	3.2	3.6	2.6	9.4	76	23.7	0.00484163
T3A 100L2-2	4	13.0	7.50	4.33	12.3	7.12	4.11	11.9	6.87	3.96	2910	88.1	88.8	88.1	0.92	2.8	3.3	2.1	9.1	77	27.6	0.00590710
T3A 112M1-2	4	13.1	7.58	4.38	12.5	7.20	4.16	12.0	6.94	4.01	2920	88.1	88.2	87	0.91	3.4	3.9	2.4	10.5	77	30.1	0.00750510
T3A 112M2-2	5.5	17.8	10.3	5.94	16.9	9.78	5.65	16.3	9.43	5.44	2920	89.2	89.6	89.1	0.91	3.3	4.2	2.9	11.9	78	35.7	0.00925127
T3A 112M3-2	7.5	23.8	13.7	7.94	22.6	13.1	7.54	21.8	12.6	7.27	2920	90.1	91.0	90.0	0.92	3.5	3.8	2.1	11.4	80	40	0.01128847
T3A 132S1-2	5.5	18.2	10.5	6.08	17.3	10.0	5.77	16.7	9.64	5.56	2930	89.2	89.4	88.2	0.89	3.2	4	2.5	10	80	43.4	0.01521165
T3A 132S2-2	7.5	23.8	13.7	7.94	22.6	13.1	7.54	21.8	12.6	7.27	2930	90.1	90.9	90.7	0.92	2.6	3.6	1.9	10.1	80	51.7	0.01899607
T3A 132M1-2	9.2	29.4	17.0	9.79	27.9	16.1	9.30	26.9	15.5	8.96	2930	90.6	91.2	90.5	0.91	3.2	4.2	2.6	11.6	81	58.3	0.02161887
T3A 132M2-2	11	34.5	19.9	11.5	32.8	18.9	10.9	31.6	18.2	10.5	2930	91.2	91.5	91.2	0.92	3.6	4.1	2.4	12.2	83	63.5	0.02414181
T3A 132M3-2	15	47.7	27.6	15.9	45.3	26.2	15.1	43.7	25.2	14.6	2940	91.9	92.1	91.2	0.9	4.9	4.9	2	14.4	86	75	0.02855696
T3A 160M1-2	11	36.1	20.8	12.0	34.3	19.8	11.4	33.0	19.1	11.0	2960	91.2	91	89.6	0.88	3.2	4	1.4	10.3	86	85.5	0.05961337
T3A 160M2-2	15	48.3	27.9	16.1	45.8	26.5	15.3	44.2	25.5	14.7	2960	91.9	91.5	89.9	0.89	3.9	4.2	1.4	11.4	86	104	0.07675122
T3A 160L1-2	18.5	57.9	33.4	19.3	55.0	31.8	18.3	53.0	30.6	17.7	2950	92.4	92.8	91.8	0.91	3	3	1.5	9.1	86	121	0.09225175
T3A 160L2-2	22	68.6	39.6	22.9	65.2	37.6	21.7	62.8	36.3	20.9	2960	92.7	92.8	92.5	0.91	3.8	4	1.6	12.7	88	132	0.10748540
T3A 180M-2	22	68.6	39.6	22.9	65.2	37.6	21.7	62.8	36.3	20.9	2960	92.7	93	92.4	0.91	2.7	3.3	1.7	9	88	130.6	0.10467740
T3A 200L1-2	30	94.0	54.3	31.3	89.3	51.6	29.8	86.1	49.7	28.7	2960	93.3	93.2	92.2	0.9	3.5	3.8	1.8	10.2	90	158	0.13673820
T3A 200L2-2	37	115.5	66.7	38.5	109.7	63.3	36.6	105.7	61.0	35.2	2960	93.7	93.6	92.6	0.9	3.6	3.7	1.7	9.8	90	173.1	0.16330820
T3A 631-4	0.12	0.70	0.40	0.23	0.66	0.38	0.22	0.64	0.37	0.21	1360	64.8	63.7	57.6	0.7	2.2	2.3	2	3.5	52	3.8	0.00030500
T3A 632-4	0.18	0.97	0.56	0.32	0.92	0.53	0.31	0.89	0.51	0.30	1400	69.9	69.6	65.4	0.7	2.2	2.5	2.1	4.1	52	4.5	0.00039900
T3A 633-4	0.25	1.27	0.73	0.42	1.21	0.70	0.40	1.16	0.67	0.39	1395	75	75.1	71.5	0.69	2.9	3	2.7	4.7	55	5.3	0.00052391
T3A 711-4	0.25	1.30	0.75	0.43	1.23	0.71	0.41	1.19	0.69	0.40	1410	73.5	73.2	69	0.69	2.3	2.5	2.1	4.5	55	5.8	0.00071700
T3A 712-4	0.37	1.85	1.07	0.62	1.76	1.02	0.59	1.70	0.98	0.57	1420	77.3	77.1	73.6	0.68	2.8	3	2.5	5.2	55	7	0.00096500
T3A 801-4	0.55	2.80	1.62	0.93	2.66	1.54	0.89	2.56	1.48	0.85	1440	80.8	79.9	76	0.64	3.1	3.3	2.4	6.2	57	9.5	0.00169042
T3A 802-4	0.75	3.47	2.00	1.16	3.29	1.90	1.10	3.17	1.83	1.06	1440	82.5	82.5	80.1	0.69	3.1	3.1	2.5	6.3	58	11.7	0.00228457
T3A 803-4	1.1	4.65	2.69	1.55	4.42	2.55	1.47	4.26	2.46	1.42	1430	84.1	84.9	83.7	0.74	3	3.1	2.6	6.6	61	13.8	0.00299754
T3A 90S-4	1.1	4.65	2.69	1.55	4.42	2.55	1.47	4.26	2.46	1.42	1440	84.1	84.1	81.8	0.74	3.7	3.8	3.1	7.7	61	15.1	0.00384181

MOTOR
PUMP &
GEARBOX



T3A Series IE3 Efficiency Motors Technical Data (at 50Hz)

Model	Power	Current(A)			Current(A)			Current(A)			Speed (r/min)	Eff.			Power Factor	T _{max} /T _n (Times)	T _{max} /T _s (Times)	T _{max} /T ₁ (Times)	I _p /I _n (Times)	Noise dB(A)	W.T (kg)	Inertia (kg*m ²)
		220V	380V	660V	230V	400V	690V	240V	415V	720V		100%	75%	50%								
T3A 90L1-4	1.5	6.34	3.66	2.11	6.02	3.48	2.01	5.80	3.35	1.93	1440	85.3	85.3	83.1	0.73	4.1	4.1	3.4	8.1	61	18	0.00468546
T3A 100L1-4	2.2	8.14	4.70	2.71	7.74	4.47	2.58	7.46	4.31	2.49	1450	86.7	87.2	86.2	0.82	2.9	3.5	2.4	8	64	23.9	0.00875401
T3A 100L2-4	3	11.5	6.66	3.85	11.0	6.33	3.65	10.6	6.10	3.52	1450	87.7	88	86.9	0.78	3.3	3.4	2.7	8.1	64	28.3	0.01106275
T3A 112M1-4	4	14.5	8.37	4.83	13.8	7.95	4.59	13.3	7.66	4.42	1450	88.6	88.8	88.2	0.82	3.1	3.7	2.6	8.6	65	33.9	0.01529165
T3A 112M2-4	5.5	20.2	11.7	6.73	19.2	11.1	6.39	18.5	10.7	6.16	1450	89.6	89.9	89.1	0.8	3.8	3.7	2.5	9.1	71	39.1	0.04875837
T3A 132S-4	5.5	19.2	11.1	6.41	18.3	10.5	6.09	17.6	10.2	5.87	1460	89.6	89.8	89.4	0.84	2.3	3.5	1.9	9	71	47.4	0.03446419
T3A 132M1-4	7.5	26.0	15.0	8.66	24.7	14.3	8.23	23.8	13.7	7.93	1460	90.4	90.9	90.3	0.84	2.6	3.4	2.2	8.9	71	57.4	0.04359680
T3A 132M2-4	9.2	32.5	18.8	10.8	30.9	17.8	10.3	29.8	17.2	9.93	1460	90.8	91.3	90.7	0.82	3.2	3.6	2	10	74	60	0.05133916
T3A 132M3-4	11	37.7	21.8	12.6	35.8	20.7	11.9	34.5	19.9	11.5	1460	91.4	92	91.6	0.84	3.5	3.7	2.1	10.5	75	67	0.06037189
T3A 160M-4	11	38.2	22.0	12.7	36.3	20.9	12.1	34.9	20.2	11.6	1470	91.4	91.7	89.8	0.83	2.6	2.8	1.8	7.6	75	89	0.10537280
T3A 160L1-4	15	50.4	29.1	16.8	47.9	27.7	16.0	46.2	26.7	15.4	1470	92.1	92.3	91.3	0.85	3	3	2	9.2	75	110.5	0.13703810
T3A 180M-4	18.5	61.1	35.3	20.4	58.1	33.5	19.4	56.0	32.3	18.7	1470	92.6	92.8	92.1	0.86	2.8	3.3	1.9	8.8	80	130	0.17329310
T3A 180L-4	22	72.4	41.8	24.1	68.8	39.7	22.9	66.3	38.3	22.1	1470	93	93.1	92.3	0.86	3	3.5	2.1	9.3	80	145.4	0.20063720
T3A 200L-4	30	95.8	55.3	32.0	91.1	52.6	30.4	87.8	50.7	29.3	1470	93.6	93.7	92.9	0.88	3.2	3.7	2.1	9.7	83	180	0.26510010
T3A 711-6	0.18	1.20	0.69	0.40	1.14	0.66	0.38	1.09	0.63	0.36	930	63.9	61	53.4	0.62	2.4	2.6	2.3	3.5	52	5.4	0.00079000
T3A 712-6	0.25	1.48	0.85	0.49	1.40	0.81	0.47	1.35	0.78	0.45	920	68.6	67.2	61.2	0.65	2.2	2.5	2.2	3.7	52	6.3	0.00102000
T3A 801-6	0.37	1.95	1.12	0.65	1.85	1.07	0.62	1.78	1.03	0.59	930	73.5	73.8	70.5	0.68	2.2	2.5	2.1	4.1	56	9.3	0.00218934
T3A 802-6	0.55	2.64	1.52	0.88	2.51	1.45	0.84	2.42	1.40	0.81	930	77.2	78.1	75.7	0.71	2.3	2.4	2.1	4.3	56	10.9	0.00293059
T3A 803-6	0.75	3.97	2.29	1.32	3.77	2.18	1.26	3.64	2.10	1.21	935	78.9	78.2	74.4	0.63	2.8	3.1	2.6	4.9	59	12.5	0.00322709
T3A 90S-6	0.75	3.73	2.16	1.24	3.55	2.05	1.18	3.42	1.97	1.14	950	78.9	80.1	78.1	0.67	2.3	2.6	2.1	4.7	59	13.8	0.00406984
T3A 90L-6	1.1	5.33	3.08	1.78	5.07	2.93	1.69	4.88	2.82	1.63	950	81	81.1	78.4	0.67	2.7	2.9	2.5	5.2	59	16.2	0.00548739
T3A 90L2-6	1.5	7.14	4.12	2.38	6.78	3.92	2.26	6.54	3.78	2.18	950	82.5	82.7	80.5	0.67	2.9	3	2.5	5.6	61	21.3	0.00689472
T3A 100L1-6	1.5	6.84	3.95	2.28	6.49	3.75	2.16	6.26	3.61	2.09	955	82.5	83	81.8	0.7	2.4	2.9	2.2	5.5	61	22.1	0.00913729
T3A 100L2-6	2.2	9.54	5.51	3.18	9.06	5.23	3.02	8.73	5.04	2.91	955	84.3	85.1	83.9	0.72	2.5	3	2.2	6.2	64	27.7	0.01272548
T3A 112M1-6	2.2	10.1	5.83	3.37	9.59	5.54	3.20	9.25	5.34	3.08	965	84.3	84.5	83.2	0.68	2	2.5	1.9	5.5	64	27.1	0.01767543
T3A 112M2-6	3	13.4	7.72	4.46	12.7	7.33	4.23	12.2	7.07	4.08	965	85.6	86.2	84.8	0.69	2.5	2.9	1.9	6.3	64	33.1	0.02140041
T3A 132S-6	3	12.5	7.20	4.15	11.8	6.84	3.95	11.4	6.59	3.80	965	85.6	86	85.1	0.74	2	2.7	1.7	6	64	38.6	0.03380429
T3A 132M1-6	4	16.4	9.46	5.46	15.6	8.99	5.19	15.0	8.66	5.00	970	86.8	87.1	86.2	0.74	2.3	3	1.8	6.8	68	47.6	0.04394565
T3A 132M2-6	5.5	23.2	13.4	7.72	22.0	12.7	7.34	21.2	12.2	7.07	975	88	88.3	87.1	0.71	2.9	3.5	2.2	7.4	68	55.7	0.05398713
T3A 132M3-6	7.5	30.8	17.8	10.3	29.2	16.9	9.74	28.2	16.3	9.39	970	89.1	89.6	88.6	0.72	3.3	3.2	2	8.3	68	67.6	0.07072295
T3A 160M-6	7.5	29.1	16.8	9.72	27.7	16.0	9.23	26.7	15.4	8.90	975	89.1	89.5	88.5	0.76	2.2	2.9	1.8	7.3	68	79.6	0.10901170
T3A 160L-6	11	41.1	23.7	13.7	39.0	22.5	13.0	37.6	21.7	12.5	975	90.3	90.8	89.9	0.78	2.7	2.9	1.2	8.4	73	105	0.15484950
T3A 180L-6	15	52.1	30.1	17.4	49.5	28.6	16.5	47.7	27.6	15.9	980	91.2	91	89.8	0.83	2.5	3.3	2.1	8.2	77	125.2	0.27515650
T3A 200L1-6	18.5	67.2	38.8	22.4	63.8	36.9	21.3	61.5	35.5	20.5	980	91.7	91.3	90	0.79	2.5	3.3	2	8.5	80	143	0.33206640
T3A 200L2-6	22	79.5	45.9	26.5	75.5	43.6	25.2	72.8	42.0	24.3	980	92.2	92	90.9	0.79	2.8	3.5	2.2	8.8	80	162	0.38831630

MOTOR
PUMP &
GEARBOX



TC Series

Three-Phase Asynchronous Motors Cast Iron Housing

FEATURES

- Energy savings, high efficiency
- High starting torque, lower starting current
- Versatile and easy to modify design adapts to a variety of applications
- Option of integrated or removable feet
- Option of terminal box location (top, left or right) up to and including 280 frames.
- Option of IE2, IE3, MEPS High and Premium Efficiency for IEC standards + NEMA EPACT and Premium Efficiency
- Contained total length is the same as or shorter than the current market standard
- Full use of the magnetization properties of cold rolled silicone steel in which the stator laminations are magnetized evenly to reduce temperature rise of the winding



APPLICATIONS

- Pumps
- Waste water treatment plants
- Air compressors, fans HVAC
- Gear reducers and power transmission
- Pulp and paper mills
- Steel mill
- Conveyors, elevators
- Should be "Material handling equipment"
- Agricultural application
- Mining equipment
- Hydraulic equipment

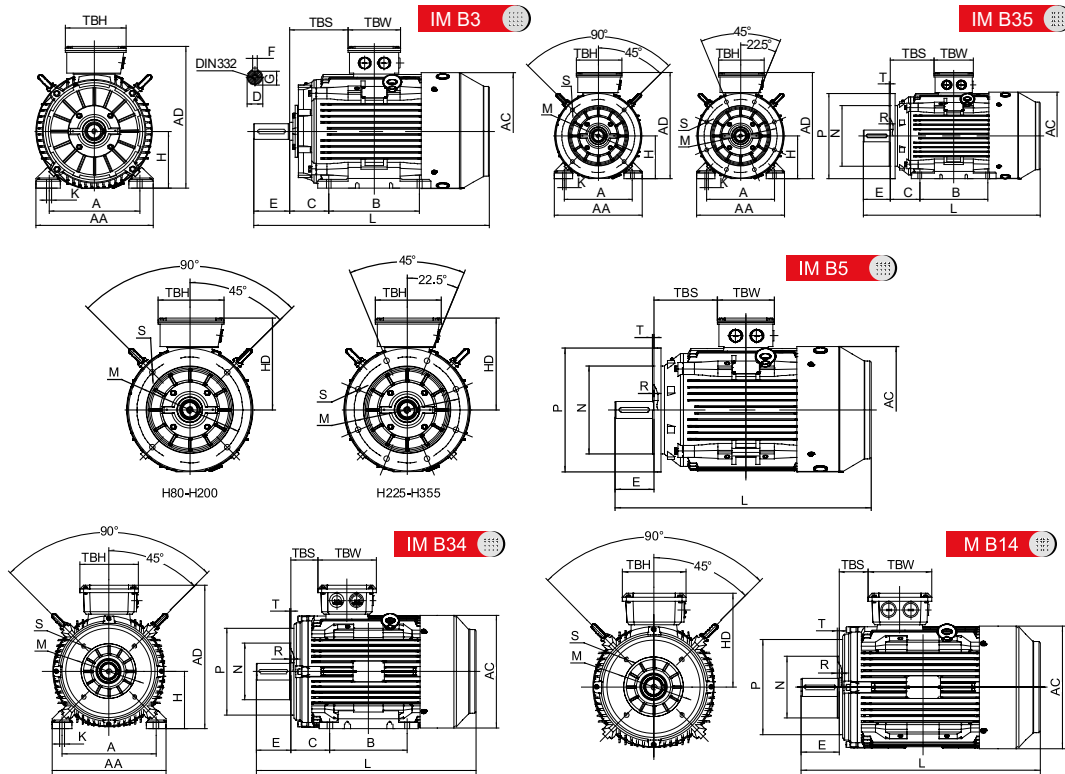

Overall & Installation Dimensions

Frame	Foot Mounting			Shaft							General						
	H	A	B	C	D	E	F	G	K	AA	AD	HD	AC	L	TBS	TBW	TBH
80	80	125	100	50	φ 19	40	6	15,5	φ 9	154	214	134	φ 158	290	43	114	114
90S/L	90	140	100/125	56	φ 24	50	8	20	φ 10	178	231	141	φ 176	320/345	49/61,5	114	114
100L	100	160	140	63	φ 28	60	8	24	φ 12	203	251	151	φ 199	385	76	114	114
112M	112	190	140	70	φ 28	60	8	24	φ 12	231	292	180	φ 220	405	73	134	134
132S/M	132	216	140/178	89	φ 38	80	10	33	φ 12	263	332	200	φ 259	467/505	61,5	134	134
160M/L	160	254	210/254	108	φ 42	110	12	37	φ 15	316	404	244	φ 313	605/650	91	162	187
180M/L	180	279	241/279	121	φ 48	110	14	42,5	φ 15	354	445	265	φ 360	687/725	160/180	162	187
200L	200	318	305	133	φ 55	110	16	49	φ 19	393	500	300	φ 399	768,5	192	186	233
225S	4,6,8	225	356	286	φ 60	140	18	53	φ 19	440	558	333	φ 459	810	199	186	233
225M	2	225	356	311	φ 55	110	16	49	φ 19	440	558	333	φ 459	805	211,5	186	233
225M	4,6,8	225	356	311	φ 60	140	18	53	φ 19	440	558	333	φ 459	835	211,5	186	233
250M	2	250	406	349	φ 60	140	18	53	φ 24	484	616	366	φ 506	915	233	218	260
250M	4,6,8	250	406	349	φ 65	140	18	58	φ 24	484	616	366	φ 506	915	233	218	260
280S/M	2	280	457	368/419	φ 65	140	18	58	φ 24	560	675	395	φ 559	984/1035	265/277	218/245	260/280
280S/M	4,6,8	280	457	368/419	φ 75	140	20	67,5	φ 24	560	675	395	φ 559	984/1035	265/277	218/245	260/280
315S	2	315	508	406	φ 65	140	18	58	φ 28	628	825	510	φ 680	1205	200	290	350
315S	4,6,8	315	508	406	φ 80	170	22	71	φ 28	628	825	510	φ 680	1235	200	290	350
315M/L	2	315	508	457/508	φ 65	140	18	58	φ 28	628	825	510	φ 680	1355	200	290	350
315M/L	4,6,8	315	508	457/508	φ 80	170	22	71	φ 28	628	825	510	φ 680	1385	200	290	350
355M/L	2	355	610	560/630	φ 75	140	20	67,5	φ 28	740	1010	655	φ 820	1495	140	330	380
355M/L	4,6,8	355	610	560/630	φ 95	170	25	86	φ 28	740	1010	655	φ 820	1525	140	330	380
355M/L	4,6,8	355	610	560/630	φ 100	210	28	90	φ 28	740	1010	655	φ 820	1565	140	330	380

Frame	Bearings		Cable Gland	B5						B14					
	DE	NDE		N	M	P	S	T	R	N	M	P	S	T	R
80		6204	1-M20×1,5	φ 130	φ 165	φ 200	4× φ 12	3,5	0	φ 80	φ 100	φ 120	M6	3	0
90S/L		6205	1-M20×1,5	φ 130	φ 165	φ 200	4× φ 12	3,5	0	95	115	140	M8	3	0
100L		6206	1-M20×1,5	φ 180	φ 215	φ 250	4× φ 15	4	0	110	130	160	M8	3,5	0
112M		6306	2-M25×1,5	φ 180	φ 215	φ 250	4× φ 15	4	0	110	130	160	M8	3,5	0
132S/M		6308	2-M25×1,5	φ 230	φ 265	φ 300	4× φ 15	4	0	130	165	200	M10	3,5	0
160M/L		6309	2-M32×1,5	φ 250	φ 300	φ 350	4× φ 19	5	0	180	215	250	M12	5	0
180M/L		6311	2-M32×1,5	φ 250	φ 300	φ 350	4× φ 19	5	0						
200L		6312	2-M40×1,5	φ 300	φ 350	φ 400	4× φ 19	5	0						
225S/M		6313	2-M50×1,5	φ 350	φ 400	φ 450	8× φ 19	5	0						
250M		6314	2-M50×1,5	φ 450	φ 500	φ 550	8× φ 19	5	0						
280S/M		6316	2-M50×1,5	φ 450	φ 500	φ 550	8× φ 19	5	0						
315S/M/L	2	6317	2-M63×1,5	φ 550	φ 600	φ 660	8× φ 24	6	0						
315S/M/L	4,6,8	NU319								6319					
355M/L	2	6319	2-M63×1,5	φ 680	φ 740	φ 800	8× φ 24	6	0						
355M/L	4,6,8	NU322								6322					



MOTOR
PUMP &
GEARBOX

T3C Series IE3 Efficiency Motors Technical Data (400V/50Hz)

Model	Output (kW)	Rated current (A)	Rotation speed (r/min)	Efficiency 100% load (%)	Efficiency 75% load (%)	Efficiency 50% load (%)	Power factor (Φ)	Rated torque (N.m)	T _{st} /T _n (Times)	T _{max} /T _n (Times)	T _{max} /T _s (Times)	I _{st} /I _n (Times)	Noise (dB)	Net weight (kg)	Moment of inertia (kg·m ²)
T3C 801-2	0.75	1.68	2880	80.7	81.0	76.2	0.80	2.49	2.5	2.1	2.8	7.5	67	15.20	0.00093
T3C 802-2	1.1	2.40	2880	82.7	83.5	81.6	0.80	3.65	2.5	1.8	2.8	8	67	17.10	0.00128
T3C 90S-2	1.5	3.06	2880	84.2	84.9	84.0	0.84	4.97	2.5	1.8	2.8	8.5	72	21.5	0.00224
T3C 90L-2	2.2	4.45	2880	85.9	86.4	84.7	0.83	7.30	2.5	1.8	2.8	8.6	72	24.6	0.00279
T3C 100L-2	3	5.65	2900	87.1	88.5	86.8	0.88	9.88	2.5	2.0	2.8	9.5	76	35.5	0.00496
T3C 112M-2	4	7.28	2910	88.1	88.5	87.1	0.90	13.13	2.5	2.0	2.8	10.5	77	44.5	0.00744
T3C 132S1-2	5.5	10.11	2910	89.2	90.2	88.6	0.88	18.05	2.5	2.0	3.0	10	80	63.2	0.01468
T3C 132S2-2	7.5	13.50	2920	90.1	90.8	89.3	0.89	24.53	2.5	1.5	3.0	10	80	70.2	0.01903
T3C 132M1-2	9.2	16.47	2920	90.6	91.2	89.5	0.89	30.09	2.5	1.5	3.0	10	80	76.8	0.02048
T3C 160M1-2	11	19.34	2930	91.2	93.8	93.0	0.90	35.85	2.5	1.4	3.0	9.5	86	118.0	0.05178
T3C 160M2-2	15	26.18	2940	91.9	93.1	92.9	0.90	48.72	2.5	1.4	3.0	10	86	128.0	0.06206
T3C 160L-2	18.5	31.76	2940	92.4	93.5	93.3	0.91	60.09	2.5	1.4	3.0	9.5	86	144.00	0.07669
T3C 180M-2	22	38.5	2945	92.7	94.1	93.6	0.89	71.34	2.5	1.4	3.0	9	89	183.40	0.09665
T3C 200L1-2	30	52.1	2945	93.3	93.8	93.2	0.89	97.3	2.5	1.5	2.5	8.5	92	247.00	0.17351
T3C 200L2-2	37	64.0	2945	93.7	94.4	94.2	0.89	120.0	2.5	1.5	2.5	8.5	92	268.00	0.20008
T3C 225M-2	45	75.9	2950	94	94.6	94.1	0.91	145.7	2.5	1.4	2.5	8.5	92	369.00	0.34366
T3C 250M-2	55	93.5	2960	94.3	94.5	93.1	0.90	177.4	2.5	1.4	2.6	10	93	428.00	0.44434
T3C 280S-2	75	125.6	2960	94.7	94.9	93.7	0.91	242.0	2.5	1.8	2.6	10	94	587.30	0.82911
T3C 280M-2	90	150.3	2960	95	95.2	94.3	0.91	290.4	2.5	1.8	2.6	10	94	655.00	0.98168
T3C 315S-2	110	185.3	2960	95.2	95.5	94.6	0.90	354.9	2.0	1.4	2.3	7	96	980.00	1.70352
T3C 315M-2	132	221.9	2960	95.4	95.5	94.7	0.90	425.9	2.0	1.4	2.3	7	96	1100.00	1.93860
T3C 315L1-2	160	267.8	2960	95.8	95.8	94.5	0.90	516.2	2.0	1.4	2.3	7	99	1155.00	2.19758
T3C 315L2-2	200	334.8	2960	95.8	96.0	94.7	0.90	645.3	2.0	1.4	2.3	7	99	1260.00	2.55368
T3C 355M1-2	220	394.6	2960	95.8	96.2	94.8	0.84	709.8	2.0	1.5	2.3	6.5	103	1590.00	2.95585
T3C 355M2-2	250	448.4	2960	95.8	96.2	94.8	0.84	806.6	2.0	1.5	2.3	6.5	103	1650.00	3.14272
T3C 355L1-2	280	502.2	2960	95.8	96.2	94.8	0.84	903.4	2.0	1.5	2.3	6.5	103	1715.00	3.47911
T3C 355L2-2	315	558.3	2960	95.8	96.2	94.8	0.85	1016.3	2.0	1.5	2.3	6.5	103	1780.00	3.85287
T3C 802-4	0.75	1.90	1420	82.5	82.8	80.6	0.69	5.04	2.8	2.2	2.8	6.3	58	18.20	0.00155
T3C 90S-4	1.1	2.62	1430	84.1	84.6	83.2	0.72	7.35	2.8	2.2	2.8	6.8	61	23.00	0.00372
T3C 90L-4	1.5	3.63	1430	85.3	86.1	85.2	0.70	10.02	2.8	2.2	3.0	7.3	61	26.30	0.00469
T3C 100L1-4	2.2	4.52	1430	86.7	87.8	85.2	0.81	14.69	2.8	2.2	3.0	8	64	35.50	0.00922
T3C 100L2-4	3	6.33	1435	87.7	88.0	85.9	0.78	19.97	2.5	2.2	3.0	8.2	64	38.50	0.01195
T3C 112M-4	4	7.95	1440	88.6	88.9	87.5	0.82	26.53	2.5	2.2	3.0	8.6	65	47.00	0.01545
T3C 132S-4	5.5	10.67	1440	89.6	90.9	88.9	0.83	36.48	2.5	1.8	3.0	9	71	68.30	0.03397
T3C 132M-4	7.5	14.09	1440	90.4	91.3	91.2	0.85	49.74	2.5	1.6	3.0	9	71	79.00	0.04412
T3C 132M2-4	9.2	17.19	1440	90.9	91.8	90.5	0.85	61.01	2.5	1.6	3.0	9	71	87.50	0.04700
T3C 160M-4	11	20.68	1450	91.4	92.2	91.7	0.84	72.45	2.5	1.3	3.0	10	75	127.00	0.10355
T3C 160L-4	15	27.33	1450	92.1	92.9	92.2	0.86	98.8	2.5	1.3	2.8	8.5	75	160.00	0.13750
T3C 180M-4	18.5	33.5	1460	92.6	93.6	93.0	0.86	121.0	2.5	1.8	3.0	9	76	169.40	0.15530
T3C 180L-4	22	39.2	1460	93	93.7	92.9	0.87	143.9	2.5	1.8	3.0	10	76	196.00	0.19433

MOTOR
PUMP &
GEARBOX



T3C Series IE3 Efficiency Motors Technical Data (400V/50Hz)

Model	Output (kW)	Rated current (A)	Rotation speed (r/min)	Efficiency 100% load (%)	Efficiency 75% load (%)	Efficiency 50% load (%)	Power factor (Φ)	Rated torque (N.m)	T _{st} /T _n (Times)	T _{max} /T _n (Times)	T _{max} /T _s (Times)	I _{st} /I _n (Times)	Noise (dB)	Net weight (kg)	Moment of inertia (kg·m ²)
T3C 200L-4	30	57.1	1470	93.6	93.7	93.2	0.81	194.9	2.5	1.8	2.8	9	79	252.00	0.29441
T3C 225S-4	37	65.4	1470	93.9	95.2	94.3	0.87	240.4	2.5	1.4	2.5	9.2	81	324.50	0.57838
T3C 225M-4	45	79.3	1470	94.2	95.2	94.5	0.87	292.3	2.5	1.5	2.5	9	81	352.90	0.65309
T3C 250M-4	55	95.4	1470	94.6	95.2	94.5	0.88	357.3	2.5	1.8	2.5	8.5	83	427.40	0.76504
T3C 280S-4	75	131.0	1480	95	95.1	94.8	0.87	484.0	2.5	1.8	2.8	10	86	673.30	1.99603
T3C 280M-4	90	160.5	1480	95.2	95.1	95.0	0.85	580.7	2.5	1.8	2.8	10	86	692.00	2.18345
T3C 315S-4	110	189.1	1480	95.4	95.7	94.6	0.88	709.8	2.2	1.5	2.6	9	93	1027.00	3.71808
T3C 315M-4	132	226.5	1480	95.6	95.8	95.0	0.88	851.8	2.2	1.5	2.6	9	93	1155.00	4.29667
T3C 315L1-4	160	273.9	1480	95.8	96.0	95.1	0.88	1032.4	2.2	1.5	2.6	9	97	1240.00	5.10990
T3C 315L2-4	200	337.9	1480	96	96.2	95.3	0.89	1290.5	2.2	1.5	2.6	9	97	1400.00	6.17334
T3C 355M1-4	220	371.7	1480	96	96.2	95.3	0.89	1419.6	2.0	1.3	2.3	8	101	1560.00	7.04227
T3C 355M2-4	250	422.3	1480	96	96.3	95.4	0.89	1613.2	2.0	1.3	2.3	8	101	1600.00	7.63820
T3C 355L1-4	280	473.0	1480	96	96.4	95.4	0.89	1806.8	2.0	1.3	2.3	8	101	1650.00	8.31927
T3C 355L2-4	315	532.1	1480	96	96.3	95.5	0.89	2032.6	2.0	1.3	2.3	8	101	1700.00	9.34080
T3C 90S-6	0.75	2.05	935	78.9	79.6	77.2	0.67	7.66	2.0	1.8	2.2	5	57	21.50	0.00435
T3C 90L-6	1.1	2.97	940	81	81.5	80.2	0.66	11.18	2.3	1.8	2.2	5.2	57	25.50	0.00611
T3C 100L-6	1.5	3.55	940	82.5	83.0	81.6	0.74	15.24	2.0	1.7	2.2	5.2	61	33.50	0.00972
T3C 112M-6	2.2	5.38	940	84.3	85.0	83.2	0.70	22.35	2.0	1.8	2.2	6.2	65	40.00	0.01637
T3C 132S-6	3	6.84	940	85.6	86.1	84.5	0.74	30.48	2.0	1.7	2.2	6	69	59.00	0.03223
T3C 132M1-6	4	8.99	950	86.8	87.6	85.2	0.74	40.21	2.0	1.6	2.5	7	69	75.50	0.04338
T3C 132M2-6	5.5	12.71	950	88	88.8	86.9	0.71	55.29	2.3	1.8	2.5	7.5	69	76.30	0.05443
T3C 160M-6	7.5	16.2	960	89.1	90.3	88.0	0.75	74.6	2.3	1.4	2.8	7.5	73	112.00	0.08726
T3C 160L-6	11	23.1	960	90.3	91.2	88.5	0.76	109.4	2.5	1.4	2.8	8.5	73	134.00	0.13544
T3C 180L-6	15	30.1	960	91.2	92.0	90.3	0.79	149.2	2.5	1.4	2.8	8	73	184.50	0.27973
T3C 200L1-6	18.5	36.4	970	91.7	92.3	90.6	0.80	182.1	2.5	1.4	2.8	9.5	76	231.00	0.38345
T3C 200L2-6	22	42.5	970	92.2	93.0	91.3	0.81	216.6	2.5	1.5	2.8	10	76	249.00	0.44941
T3C 225M-6	30	53.0	975	92.9	93.8	90.9	0.88	293.8	1.8	1.5	2.2	7	76	339.00	0.67058
T3C 250M-6	37	67.3	975	93.3	94.0	91.8	0.85	362.4	1.8	1.3	2.0	7	78	399.40	0.99243
T3C 280S-6	45	83.5	980	93.7	94.6	92.7	0.83	438.5	2.5	1.8	2.8	10	80	551.00	2.20274
T3C 280M1-6	55	99.3	980	94.1	95.0	93.4	0.85	536.0	2.5	1.8	2.8	10	80	624.30	2.57302
T3C 315S-6	75	139.6	980	94.6	94.8	93.2	0.82	730.9	2.0	1.3	2.3	7.5	85	860.00	3.80317
T3C 315M-6	90	166.9	980	94.9	95	93.4	0.82	877.0	2.0	1.3	2.3	7.5	85	970.00	4.45274
T3C 315L1-6	110	203.6	980	95.1	95.4	94	0.82	1071.9	2.0	1.3	2.3	7.5	85	1070.00	5.53956
T3C 315L2-6	132	243.6	980	95.4	95.7	94.2	0.82	1286.3	2.0	1.3	2.3	7.5	85	1196.00	6.62638
T3C 355M1-6	160	294.6	980	95.6	95.8	94.3	0.82	1559.2	2.0	1.3	2.3	7.5	92	1537.00	8.97637
T3C 355M2-6	200	367.5	980	95.8	95.8	94.3	0.82	1949.0	2.0	1.3	2.3	7.5	92	1720.00	11.00175
T3C 355L1-6	220	404.2	980	95.8	96	94.2	0.82	2143.9	2.0	1.3	2.3	7.5	92	1800.00	11.64134
T3C 355L-6	250	459.3	980	95.8	96	94.3	0.82	2436.2	2.0	1.3	2.3	7.5	92	1880.00	13.56011

MOTOR
PUMP &
GEARBOX





Large Frame LV Motors



Total Engineering Commitment

- Ex stock up to 630kW in 2 and 4 pole in IEC 400 Frame
- Ex stock up to 500kW in 2 and 4 pole in compact 355X frame
- WIMES compliant
- IE3 high efficiency
- PTC150°C in winding
- PT100's in winding and bearing
- 1 x 110v & 1 x 230v space heaters
- VFD ready with insulated bearing/NDE shield
- Epoxy paint finish

Critical Dimensions Overview:

Frame	Power Ratings	Poles	Shaft Comparison						
			D Shaft Dia	E Shaft Length	F Key Width	G Dia To Keyway	DH Centre Hole	L Length Incl. Shaft	Length Without Shaft
355X	400kW/450kW/500kW	2	75	140	20	67.5	M20	1880	1740
355X	400kW/450kW/500kW	4	100	210	28	90	M24	1910	1700
355LY	355kW	2	80	170	22	71	M24	1526	1356
355LY	355kW	4	100	210	28	90	M24	1556	1346
400	400kW/500kW/630kW	2	80	170	22	71	M24	1820	1650
400	400kW/500kW/630kW	4	110	210	28	100	M24	1920	1710

Foot Fixing Comparison				
A	C	B	B1	B2
Fixing Holes Across	Shaft Shoulder To First Fixing	Front To Rear 1st Fixing	Front To Rear 2nd Fixing	Front To Rear 3rd Fixing
630	254	630	710	800
630	254	630	710	800
610	254	560	630	-
610	254	560	630	-
686	280	630	710	-
686	280	630	710	-





Introducing the TEC Gearbox Range

"With the right partner the battle is already won"

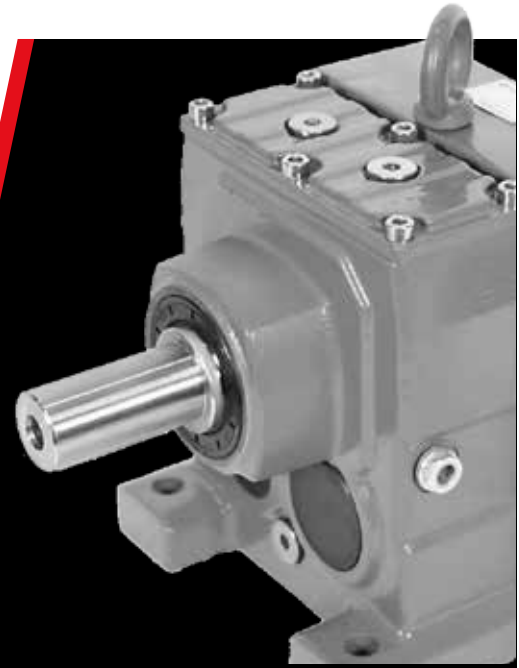

The Gearbox Range with Industry in mind

The newly developed TEC Gearbox range is the product of market feedback designed with availability and ease of use in mind.

A hard-wearing product line dimensionally interchangeable with the European standard.

MOTOR
PUMP &
GEARBOX

TCNDK



TEC Worm Gearboxes

Ratio: 5-100/1
Torque: Up to 1520nm
Hollow Bore: 11-60mm
Features: Alternative Bore, Solid Input, Double Reduction, Flanges, Shafts, Torque Arms

WKA



TEC Bevel Helical Gearboxes

Ratio: 7-250/1
Torque: Up to 22,400nm
Hollow Bore: 30-160mm
Features: IEC Standard Input Flange, Alternative Bore, Flanges, Shafts, Torque Brackets

WR/WRF

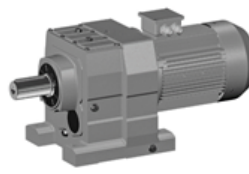

TEC Coaxial Gearboxes

Ratio: 1.5-250/1
Torque: Up to 22,400nm
Output Shaft: 20-120mm
Features: IEC Standard Input Flange, B5 Output Flange, Alternative Shaft Sizes.

WAH

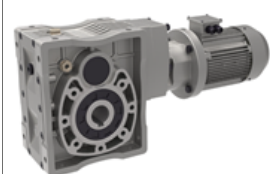

TEC Hypoid Helical Gearboxes

Ratio: 7-300/1
Torque: Up to 500nm
Hollow Bore: 20-38mm
Features: Alternative Bores, 2/3 Stage Reduction, Flanges, Shafts, Torque Arms





TECDrive Inverter Range

Easy to Use General Purpose Drive

Focused on ease of use, TECDrive provides unrivalled simplicity of installation, connection and commissioning, allowing the user to benefit from precise motor control and energy savings within minutes.

IP20

Up to 37kW

- Easy to use
- Compact & robust

IP66

Up to 22kW

- Outdoor rated
- Dust-tight
- Washdown ready
- Switched option available as seen below.





Total Engineering Commitment

TEC's extensive product range includes:

	TECA/TA Aluminium Motors 56-200 Frame
	TPC and TCC 1PH Aluminium Motors 56-112 Frame (including 3.7kW!)
	Elprom Zone 1 Exd Motors 63-180 Frame stocked
	TCNDK Worm Boxes Size 30-150
	Official UK Varvel Distributor
	TEC DC motors

	ECOL Cast Iron 80-355 Frame
	TECA BM Brake Motors 71-200 Frame
	TEC Zone 2 EXNA and Zone 22 EXTD 56-315 Frame
	Lightweight, High Efficiency Hypoid Gear Units
	TEC Drive General Purpose Inverter Range
	B48 and B56 Motors

MOTOR
PUMP &
GEARBOX

WIMES Compliant



All stock motors meet WIMES standards and are inverter ready

Need a Special Paint Finish?



TEC can paint motors up to C5M - ISO12994 upon request at our in-house painting booth

MV/HV Motors up to 8 MW



TEC also offers medium & high voltage motors up to 8MW and in voltages 3.3kV, 6.6kV, 10kV and 13.8kV



www.iadaltd.co.uk

24/7, 365 - SERVICE THAT NEVER STOPS



VF W series worm gearmotors

Torque range 13 ... 7,100 Nm
Mechanical rating 0.04 ... 75kW
Gear ratios 7 ... 10000



C series in-line helical gearmotors

Torque range 45 ... 12,000 Nm
Mechanical rating 0.08 ... 213kW
Gear ratios 2,6 ... 1481



A series helical bevel gearmotors

Torque range 100 ... 14,000 Nm
Mechanical rating 0.22 ... 150kW
Gear ratios 5,4 ... 1715



300 series planetary gearmotors

Torque range 1,000 ... 1,100,000 Nm
Mechanical rating up to 450 kW
Gear ratios 3,4 ... 5000



S series single reduction helical gearmotors

Torque range 21 ... 200 Nm
Mechanical rating 0.12 ... 11,6 kW
Gear ratios 1,4 ... 13,1



TA series shaft mounted speed reducers

Torque range 150 ... 16,000 Nm
Mechanical rating 1,1 ... 156 kW
Gear ratios 5 ... 31,5

MOTOR
PUMP &
GEARBOX



 **Bonfiglioli**
We engineer dreams

Our philosophy has always been to keep things simple. Why overcomplicate things looking for a magic formula. In today's market stocking complete geared motors is no longer the solution. To ensure a fast reliable service and short lead times local assembly is the way forward, achieved by investing in build centres across the world.

Our formula for success is simple...

Local assembly = fast reliable delivery = less downtime

MOTOR
PUMP &
GEARBOX



RAN series bevel gearboxes

Torque range 3 ... 3,000 Nm
Mechanical rating 0.15 ... 91 kW
Gear ratios 1 ... 7,4



F series shaft mounted gearmotors

Torque range 140 ... 14,000 Nm
Mechanical rating 0.17 ... 125 kW
Gear ratios 6,4 ... 2099



HDO series bevel helical gear units (Heavy Duty)

Torque range 25,650 ... 194,050 Nm
Gear ratios 5,6 ... 400



HDP series parallel shaft gear units (Heavy Duty)

Torque range 5,000 ... 194,050 Nm
Gear ratios 7,1 ... 500



BN series AC motors & brake motors

kW rating 0.06 ... 30 kW
Frame sizes 56A ... 200L
Compliance 2006/95/EC (LVD) & 2004/108/EC (EMC)



BX series IE3 premium efficiency AC motors

kW rating 0.75 ... 22 kW
Frame sizes 80B ... 180L
Compliance IEC 60034-30:2008(IE), 640/2009/EC 2006/95/EC (LVD) & 2004/108/EC (EMC)



HDO Series
The new generation



Historically Bonfiglioli has always been well known in the market for high quality worm gearboxes and small to medium power geared motors. Much has changed since 1956 with significant investment in the heavy duty gearbox range putting us firmly on the map for this sector.

The range now offers output torque ratings up to 1.25 million Nm with higher ratings being developed.

Demanding applications? Don't compromise on quality.

Fluid Circulation Specialists

Industry Leading Sales, Manufacturing & Service for the UK Pump Industry

Trusted by the Best



Pump Sourcing & Distribution

With access to in excess of £3m stock holding within the UK – we are perfectly placed to cater for all your pumping needs.

With the teams expansive product knowledge, we know which products to advise on to suit various applications enabling quick delivery timeframes.

From circulators to submersibles and everything in-between – We can get it all.





System Commissions

Increasingly complex pump systems require precise set up to ensure maximum efficiency and optimum performance.

We don't just deliver product to site and leave it there – We also offer the service of either working alongside your engineers to install or fully offer the commissioning of products to your requirements.

From single pump, to bespoke booster and complete packaged plantroom commissioning; We can offer it all.

Product Servicing

Some products make commercial sense to maintain for longer periods of time through planned/preventative maintenance.

We can offer routine maintenance contracts on an annual or bi-annual basis to suit customer requirements.

Where others may struggle with less widely used pumps – particularly industrial pumps; this is where our knowledge base really makes our engineers stand out over and above the competition.



MOTOR
PUMP &
GEARBOX



Booster Sets

Covering premium booster sets, combined booster and tank sets – Along with the Trebles Eco-Boost and Eco-Boost+ ranges.

These units are available in single, twin and multiple pump arrangements.

We can offer custom made or bespoke booster sets to suit our customer's specific needs. These can include external applications where equipment is enclosed within a weatherproof kiosk.

Centrifugal Pumps

Manufactured as standard with cast iron or stainless steel pump body. Suitable for pumping hot and cold, moderately aggressive liquids.



Single Stage Pumps

Manufactured as standard with cast iron or stainless steel pump body. Suitable for pumping hot and cold, moderately aggressive liquids.

Available: Close-coupled with special motor shaft extension, stub shaft and standard motor or with flexible coupling, adapter, base and standard motor in compliance with EN 733 – DIN 24255.



Multistage Pumps

Using multiple impellers on a common shaft to delivery high pressure, their corrosion resistant liquid-ends and heavy-duty drive-ends are essential features in continuous duty applications.

Available: In vertical and horizontal for boiler feed, carwash, washdown, pressure cleaning, reverse osmosis, chemical and oil processing.



Circulator Pumps

The most common heating pumps are these small (generally under 2kw), single phase, high efficiency circulators.

Available: In single or twin head versions.



Inline Pumps

For larger heating and cooling application as well as process pumps, these inline designs can be single or three phase powered, fixed speed or inverter driven.

Available: In single or twin pump versions.



Self-Priming Pumps

Ideal for transporting liquids containing solids in suspension. Suited for applications where the main feature is the difficulty in priming and are used across industry, construction and emergency.

Available: In cast iron, marine bronze or stainless steel.



Submersible Pumps

For use in markets ranging from water and wastewater treatment, raw water supply, abrasive or contaminated industrial processes, mining and irrigation.

Available: As a stand-alone pump, with or without integral level control, or as an easy install packaged pumping station ensuring minimal on-site work.

MOTOR
PUMP &
GEARBOX

Positive Displacement Pumps

Self-priming by design. Suitable for handling viscous products which may also contain solids.



Air Operated Pumps

Air Operated Diaphragm Pumps are easy to use and maintain, have infinitely variable flow control, can suction lift up to 8m, run dry and operate against closed valve without damage.

Available: In a variety of both metal and plastic constructions.



Progressive Cavity

Ideal for handling slurries, viscous and shear sensitive products. Multi-stage pumps are available for high pressure applications or where accurate dosing is required.

Available: In a variety of metals with a huge array of stator materials to suit any application.



Gear Pumps

Used in industrial plants for pumping liquids of any viscosity without solids in suspension: Chemicals and petroleum products, soaps and detergents, adhesives, paint and ink, high temperature liquids and chocolate.

Available: In external and internal gear options.



Screw Pumps

They can handle virtually any non-homogenous fluid, regardless of viscosity, lubricity or abrasiveness e.g. seawater, bitumen, molasses, lime, acid, caustic solution or hydrocarbon.

Available: In high pressure, high capacity, compact and hygienic versions.



Flexible Impeller Pumps

Reversible pump offers smooth, low pulsating, low shear flow. Stainless steel and bronze casings are available for hygienic and marine applications.

Available: Impellers are produced in a variety of materials, (e.g. Natural Rubber, Neoprene, Nitrile and EPDM) making them compatible with a range of fluids.



Peristaltic Pumps

Hose pumps are seal-less, can dry run without damage and self-prime up to 9.8m. Used widely for pumping minerals, ceramics, chemicals and inks/dyes at pressures up to 15 bar.

Available: As a close-coupled unit, constructed in Aluminium or Cast Iron and with a wide variety of hose materials suitable for any application.

MOTOR
PUMP &
GEARBOX

Specialist Pumps

Available in a variety of configurations, materials and finishes appropriate for a huge range of specialist applications.



Dosing Pumps

These are used for precise dosing of fluids with highly varied viscosities, most of which are chemically aggressive and toxic, and some of which are actually abrasive or emit gasses.

Available: In solenoid, motor and stepper motor driven, diaphragm and piston construction.



Drum Pumps

Drum and container pumps are constructed to assure safety and economy when transferring neutral, aggressive and flammable liquids from different-sized containers. Used for pumping aqueous and light viscous liquids.

Available: In a variety of standard materials and stem lengths.



Hygienic Pumps

Designed to reduce the build-up of bacteria by minimising crevices and dead areas. Consideration is paid to the ease with which the pump can be disassembled for manual cleaning.

- Centrifugal,
- Self-priming
- Cleaning-in-place



Rotary Lobe Pumps

Hygienic – approved to relevant standards, offering gentle pumping action to suit viscous, delicate and particle-laden liquids. Easy to clean, easy to maintain.

Available: In AISI316 stainless steel construction.



ATEX Pumps

For hazardous areas, we can provide ATEX pumps and safety devices.

If you have specific flammable gasses or dust present in the atmosphere and temperature limit requirements within the pump installation envelope, we can provide you with a solution.



Packages

Off the shelf or bespoke, automatic packaged sets, designed and built to the highest standards.

Available: In fixed or trolley mounted configuration, fixed or variable speed, complete with pipework, valves, control panel and flow / pressure / temperature sensors.

MOTOR
PUMP &
GEARBOX

Our pump brands we supply:



MOTOR
PUMP &
GEARBOX